

TOY FAIR NEWS 2023



NZGI Nürnberger Zinkdruckguss-Modelle GmbH



SPIELWARENMESSE  
NÜRNBERG

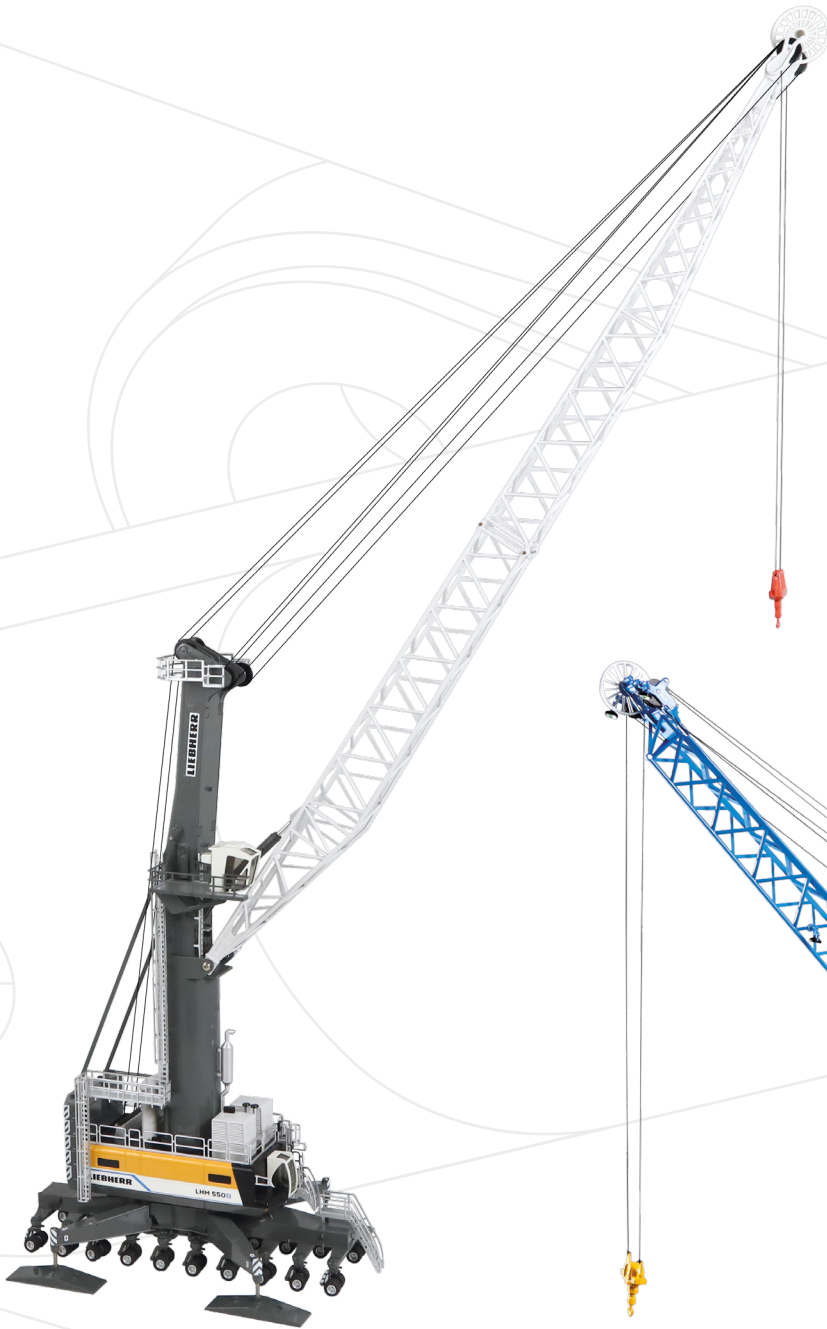

**Liebherr LHM 550**  
**Mobiler Hafenkran / Mobile harbour crane**

Maßstab / Scale : 1:87  
Länge / Length : 650 mm

**Art.-No. 8951**

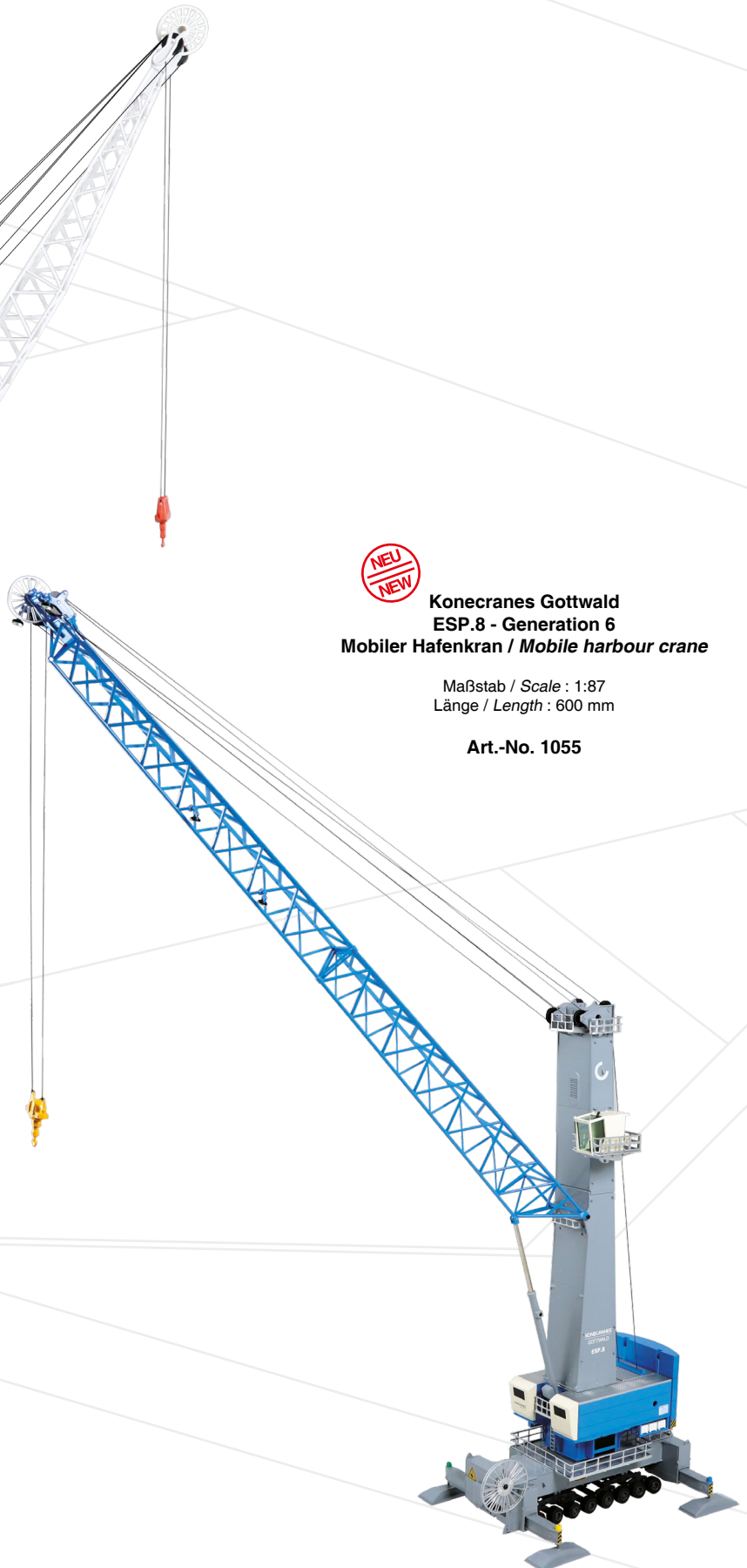

**Konecranes Gottwald**  
**ESP.8 - Generation 6**  
**Mobiler Hafenkran / Mobile harbour crane**

Maßstab / Scale : 1:87  
Länge / Length : 600 mm

**Art.-No. 1055**

**1:87**



**Liebherr LTM 1250-5.1  
Mobilkran / Mobile Crane  
„van den Brink“**

(Newsletter 07/2022)

Maßstab / Scale : 1:50  
Länge / Length : 325 mm

max. Höhe / max. height  
Ausleger / Boom: 1235 mm  
mit Gitterspitze / with lattice jib: 1650 mm

Art.-No. 959/21



**Baljer & Zembrod  
Sortier- & Umschlagwagen /  
Sorting and transferring carriage**

(Newsletter 15/2022)

Maßstab / Scale : 1:50  
Länge / Length : 355 mm

Art.-No. 1045



Holzgreifer inklusive /  
log grab included



**Liebherr L 504 Compact  
Radlader / Wheel loader**

(Newsletter 14/2022)

Maßstab / Scale : 1:50  
Länge / Length : 120 mm

**Art.-No. 1035**



**Liebherr L 586  
Radlader / Wheel loader**

Maßstab / Scale : 1:50  
Länge / Length : 200 mm

**Art.-No. 10061**



neues Design /  
new design

**Liebherr R 9600  
Tieflöffel Minenbagger /  
Backhoe mining excavator**

(Newsletter 18/2022)

Maßstab / Scale : 1:50  
Länge / Length : 470 mm

**Art.-No. 1050**





**Liebherr A 918 Compact Litronic**  
**Hydraulikbagger / Hydraulic excavator**

Maßstab / Scale : 1:50  
 Länge / Length : 145 mm

**Art.-No. 9432**



neues Design /  
 new design



neues Design /  
 new design



**Liebherr LH 22 M Litronic**  
**Materialumschlagmaschine /**  
**Material handler**

Maßstab / Scale : 1:50  
 Länge / Length : 190 mm

**Art.-No. 10012**



**Liebherr PR 736 G8**  
**Planierdraupe / Crawler tractor**

Maßstab / Scale : 1:50  
 Länge / Length : 150 mm

**Art.-No. 10101**



neues Design /  
 new design

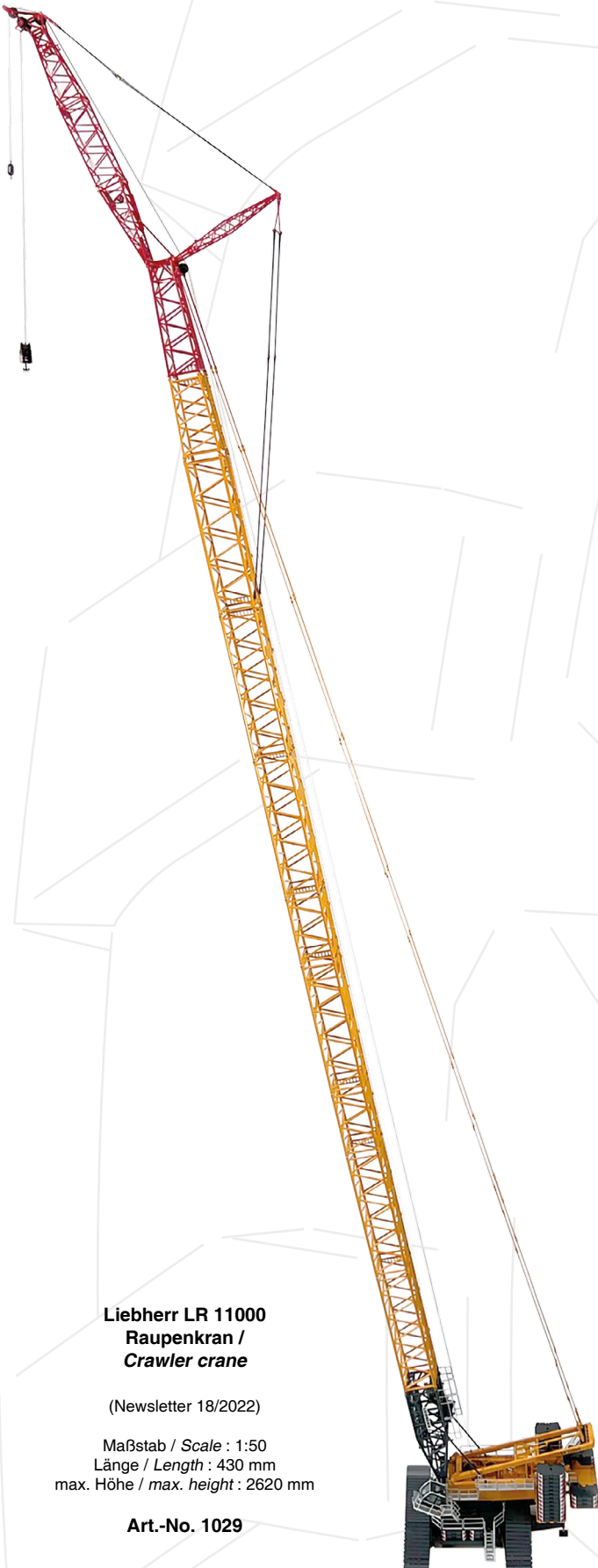

**Liebherr LR 11000**  
Raupenkran /  
Crawler crane

(Newsletter 18/2022)

Maßstab / Scale : 1:50  
Länge / Length : 430 mm  
max. Höhe / max. height : 2620 mm

**Art.-No. 1029**



inklusive Fallgewicht /  
including falling weight

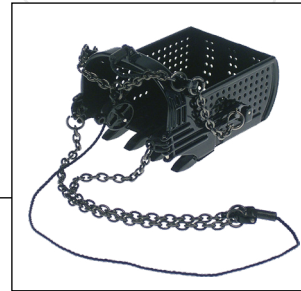

inklusive Schleppschaufel /  
including tugshovel



**Liebherr HS 8130.1 HD**  
Seilbagger /  
Duty cycle crawler crane

(Newsletter 18/2022)

Maßstab / Scale : 1:50  
Länge / Length : 400 mm  
max. Höhe / max. Height : 670 mm

**Art.-No. 1046**



**Vögele Super 1900-5i**  
Straßendeckenfertiger /  
Tracked paver

(Newsletter 18/2022)

Maßstab / Scale : 1:50  
Länge / Length : 145 mm

**Art.-No. 1039**



**Vögele Super 2100-5i**  
Straßendeckenfertiger /  
Tracked paver

(Newsletter 18/2022)

Maßstab / Scale : 1:50  
Länge / Length : 150 mm

**Art.-No. 1040**



**Kleemann MSS 802i EVO**  
Mobile Siebanlage /  
Mobile screening plant

(Newsletter 18/2022)

Maßstab / Scale : 1:50  
Länge / Length : 370 mm

**Art.-No. 1044**

**Kleemann MC 110 EVO2**  
Mobiler Backenbrecher /  
Mobile jaw crusher

Maßstab / Scale : 1:50  
Länge / Length : 330 mm

**Art.-No. 1043**



**Hamm HC 119**  
**Walzenzug mit Glattbandage & Schutzdach /**  
**Compactor with smooth roller drum & roof**

(Newsletter 18/2022)

Maßstab / Scale : 1:50  
 Länge / Length : 120 mm

**Art.-No. 1042**



**Hamm HC 119i**  
**Walzenzug mit Glattbandage & Schutzdach /**  
**Compactor with smooth roller drum & roof**

(Newsletter 18/2022)

Maßstab / Scale : 1:50  
 Länge / Length : 120 mm

**Art.-No. 10421**

**Hamm HC 200**  
**Walzenzug mit Glattbandage /**  
**Compactor with smooth roller drum**

(Newsletter 18/2022)

Maßstab / Scale : 1:50  
 Länge / Length : 135 mm

**Art.-No. 1041**



**Hamm HC 200i C**  
**Walzenzug mit Glattbandage /**  
**Compactor with smooth roller drum**

(Newsletter 18/2022)

Maßstab / Scale : 1:50  
 Länge / Length : 135 mm

**Art.-No. 10411**

**Wirtgen 220 SM 3.8**  
**Surface Miner**

(Newsletter 11/2022)

Maßstab / Scale : 1:50  
 Länge / Length : 210 mm

**Art.-No. 1036**





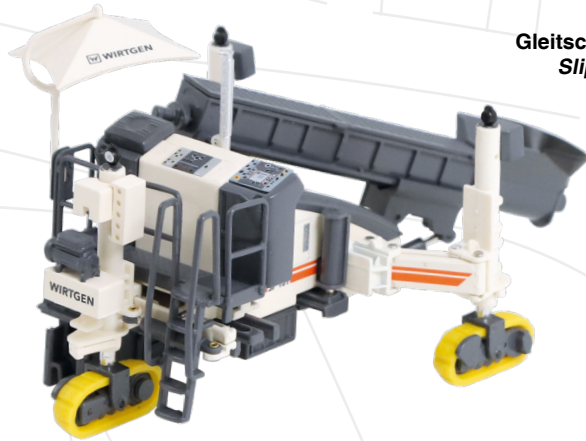

**Wirtgen SP 15 i**  
**Gleitschalungsfertiger mit Zuführschnecke /**  
**Slipform paver with auger conveyor**

(Newsletter 05/2022)

Maßstab / Scale : 1:50  
 Länge / Length : 145 mm

**Art.-No. 1054**

**Wirtgen W 120 Fi**  
**Kaltfräse /**  
**Cold milling machine**

(Newsletter 18/2022)

Maßstab / Scale : 1:50  
 Länge / Length : 270 mm

**Art.-No. 1037**



**Wirtgen SP 64 i**  
**Gleitschalungsfertiger /**  
**Slipform paver**

(Newsletter 18/2022)

Maßstab / Scale : 1:50  
 Länge / Length : 210 mm

**Art.-No. 1038**

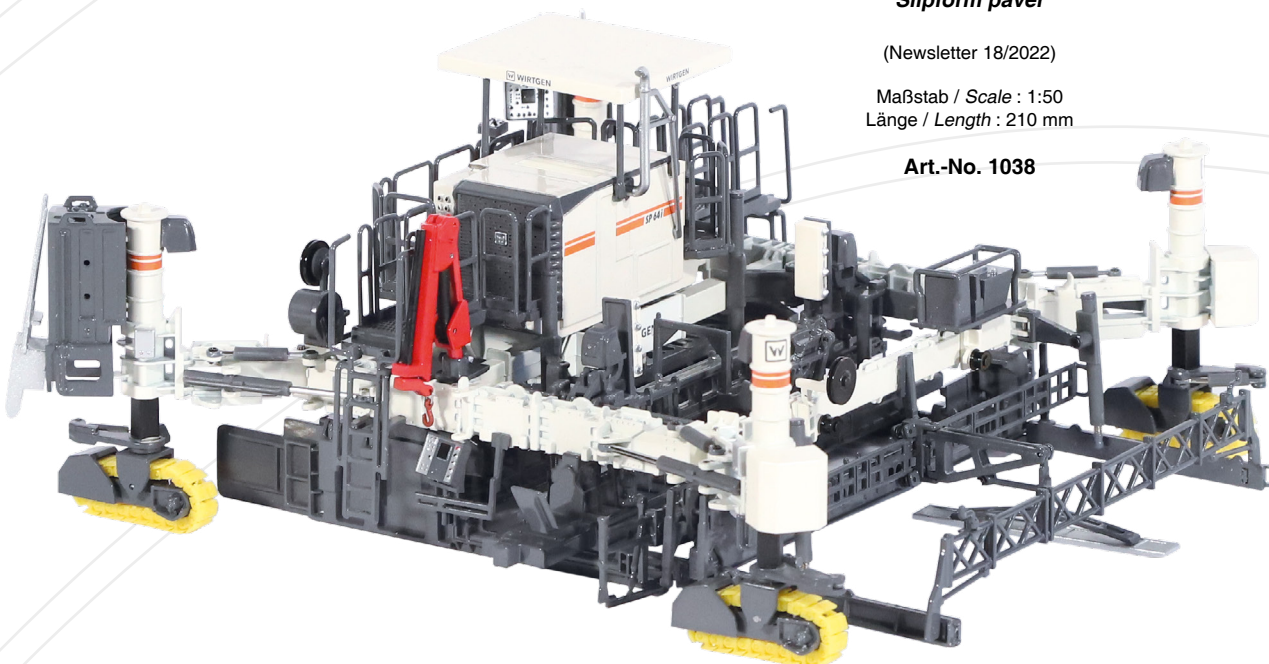



**Schwing S 51 SX**  
**Mercedes-Benz Arocs 10x4**  
**Autobetonpumpe /**  
**Truck mounted concrete pump**

(Newsletter 18/2022)

Maßstab / Scale : 1:50  
Länge / Length : 230 mm

**Art.-No.: 1062**



**Schwing SLM 4600**  
Selbstladender Fahrmischer /  
Self loading mixer

Maßstab / Scale : 1:50  
Länge / Length : 110 mm

Art.-No.: 1056



„Weiß / White“

Art.-No. 1066/40

**Mercedes-Benz Arocs 8x4**  
MirrorCam  
Meiller-Kipper

(Newsletter 12/2022)

Maßstab / Scale : 1:50  
Länge / Length : 175 mm



„Silbergrau / Silver grey“

Art.-No. 1066/55



„Blau / Blue“

Art.-No. 1066/20





**NZG**  
**Nürnberger**  
**Zinkdruckguss-Modelle GmbH**  
**Sigmundstraße 147**  
**90431 Nürnberg**  
**Germany**

**phone: +49 911 659650**  
**fax: +49 911 611776**

**email: [info@nzg.de](mailto:info@nzg.de)**

 **NZG Modelle**

**[www.nzg.de](http://www.nzg.de)**

Alle Rechte liegen bei NZG. Jedwede Weiterverarbeitung, insbesondere Herstellung und Verkauf von Kopien, Nachgüssen sowie Umbauten oder Verbreitung von in Farbe bzw. Beschriftung oder sonstigen Merkmalen veränderten NZG-Modellen ist untersagt und wird im Falle der Zuwiderhandlung zivilrechtlich und strafrechtlich verfolgt.  
Modell- und Farbänderungen sind vorbehalten.  
NZG<sup>®</sup> und seine Markenzeichen sind auf NZG Nürnberger Zinkdruckguss-Modelle GmbH eingetragene Schutzrechte.  
Marken-, Geschmacksmuster und Urheberrechte werden mit der Erlaubnis des jeweiligen Inhabers benutzt.

*All rights are reserved to NZG. Any kind of processing - especially the production and sale of copies, imitated castings as well as conversions or the distribution of NZG models in which painting, inscriptions or other features have been changed - is prohibited and will be prosecuted in the case of contravention.  
The line of products is subjected to change without notice.  
NZG<sup>®</sup> and their design marks are registered trademarks of NZG Nürnberger Zinkdruckguss-Modelle GmbH  
Brands, design rights and copyrights to be used by authority of the respective holder.*

 and Mercedes-Benz are the intellectual property of Mercedes-Benz Group AG.  
They are used by NZG Modelle GmbH under license.

All truck-specific claims, trademarks, logos and designs may be intellectual property of Daimler Truck AG and are used by NZG Modelle GmbH under license.