

# *Electronics for Model Railroads*

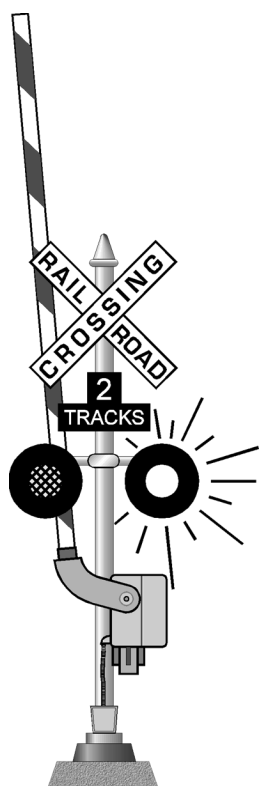

**CATALOG  
AND  
APPLICATION  
BOOK**

**No. 302**

# WELCOME

Many exciting changes have occurred in model railroading during the last 35 years. The introduction of practical instant set adhesives has greatly simplified scratch-building models. A seemingly endless variety of new low-cost plastic model structures have been introduced by a number of new manufacturers. Realistic, simple to use scenery materials abound. Water-based paints have changed the way we finish our models, and made our work-place much more comfortable in the process. Fabulously detailed rolling stock and great-running new locomotives have been introduced. And... Digital Command Control and **electronic technology** have changed the way we view and interact with our models and revolutionized the control of our layouts. Even the most exactly created miniature scenes, no matter how finely detailed they might be, take on a whole new dimension when miniature lamps, flashing crossbuck signals and operating block signals are added.

**CIRCUITRON** has been the *key* player in this *electronic revolution* and has grown over the years to become the most recognized and respected name in the industry. We pioneered the use of simple optical detection with integrated circuit controls which allows modelers in *any* scale to achieve *Electronic Realism™* without modifications to their locomotives or rolling stock. Our TORTOISE™ Slow Motion Switch Machine has revolutionized the control of turnouts and is the recognized leader in this diverse field. Our simple hookups and detailed instruction sheets have allowed many thousands of modelers with no electronics knowledge the ability to add sophisticated animation and controls to their layouts without trouble or pain. Our warranty and customer support are unmatched in the industry, and we have grown to offer the widest variety of circuits and components of any model railroad manufacturer. All our circuits have been designed by a lifelong model railroader and will definitely bring new excitement and an added dimension of incredible realism to your model railroad.

When **CIRCUITRON** first started in this business, we introduced a philosophy that model railroad electronics should be simple,

reliable, easy to connect and fairly priced. Although we have expanded from our original 4 products in 1978 to the almost 250 part numbers listed in this catalog, this policy is still an integral part of *every* product we sell, and we are certain you will find it a welcome change. The following features are built into **every CIRCUITRON** product:

- **No electronics knowledge is necessary** to hook up any **CIRCUITRON** product.
- All **CIRCUITRON** products are **completely assembled and tested**.
- If preferred, **no soldering is required** to make connections to the circuit boards.
- **Complete, detailed, step by step instructions** included with every circuit.
- We utilize only **premium quality components** and industrial grade epoxy copper clad laminate circuit boards for the **highest possible reliability**.
- All our 5000 series signaling and control circuits are designed for **easy, snap-in mounting** in a section of our optional PCMT (Printed Circuit Mounting Track).
- All **CIRCUITRON** products have been designed by a lifelong model railroader who *knows* what is needed to **accurately duplicate the prototype in miniature**.

On a personal note, I'd like to take the time to thank the many thousands of you that have supported us by purchasing our products over the years. And a big thanks to all of you who have taken the time to offer your comments, suggestions and questions. They are always appreciated, and your input helps to make this a better catalog. This *is* a fun business, and I enjoy working *with* you as much as *for* you.

Finally... to those of you who are new to this exciting aspect of our hobby, I sincerely hope that this catalog will inform and inspire you. I am certain you will find your investment to be richly rewarding. **All Aboard!** Welcome to the **CIRCUITRON** world of **Electronic Realism™**.

Please visit our website at:

**WWW.CIRCUITRON.COM**

Steve Worack, PRESIDENT

# INDEX

BOLDFACED LISTINGS ARE SECTION TITLES

<b>ACCESSORIES</b> .....	47-48	Optical Fiber .....	43
Alternating Flashers .....	19-21	Opto-Sensors .....	47
Amtrak Strobe .....	9	PCMT .....	48
Arc Welder Circuits .....	42	Polarity Reversers - Automatic .....	29
Automatic Reverse Circuits .....	29	Power Booster Circuit .....	37
Automatic Slowdown Circuit .....	30	Power Sources .....	6
Automatic Turnout Controls .....	33	<b>POWER SUPPLIES</b> .....	38-39
Basic Flashers .....	12	Emergency Flasher .....	39
Battery Holders .....	48	Filtered .....	39
Bell Circuits .....	21	Regulated .....	39
Block Occupancy Detectors .....	24-26, 28	Regulated and Adjustable .....	39
Block Signaling Circuits .....	24-26, 28	Printed Circuit Mounting Track .....	48
Bulbs - Light .....	See Lamps	Progressive Lamp Circuits .....	41
Caboose Flasher .....	11	Pushbutton .....	48
Camp Fire Circuit .....	See Arc Welder & FIRELITES™	Quick Connects .....	48
Capacitor Discharge Circuits .....	32-33	Reed Switch Kits .....	14
Chase Lights .....	41	Regulated AC to DC Converter .....	39
Constant Lighting .....	13	Relay Circuits .....	31
Converters - Power Supply .....	38-39	Remote Signal Activator—RSA .....	36
<b>DETECTION CIRCUITS AND SYSTEMS</b>		Remote TORTOISE™ Mount—RTM .....	36
An Overview .....	15-16	Reverse Circuits .....	29
Block Occupancy .....	24-26, 28	Reverse Loop Controller .....	29
Grade Crossing .....	17-19, 22	Rolling Stock Detector .....	23
Rolling Stock .....	23	Semaphore Animators .....	28
Universal .....	23	Semaphore Driver .....	26
Diesel Horn .....	40	Sequencing Strobe .....	42
Diodes .....	48	<b>SIGNAL CIRCUITS</b> .....	24-27, 28
Ditch Lights .....	10	Signal Driver Circuits .....	26-27
Drilling Template—TORTOISE™ .....	36	<b>SIMPLE CIRCUITS™</b>	
Emergency Flasher .....	12	Block Signal Animators .....	28
End of Train (EOT) Flasher .....	11	Grade Crossing Animators .....	22
External Relay Circuits .....	31	Semaphore Animators .....	28
Fiber Optics .....	43	Slide Switches .....	47
FIRELITES™ - Flickering Flame Circuits .....	42	Slowdown Circuits .....	30
Filtered AC to DC Converter .....	39	The <b>SMAIL™</b> .....	35
<b>FLASHERS</b>		<b>SNAPPER™</b> Switch Machine Power Supply .....	32-33
Alternating .....	19-21	<b>SOLDERING</b> .....	7
Basic Lamp .....	12	Solderless Connectors .....	48
Basic LED .....	12	<b>SOUND CIRCUITS</b> .....	21, 40
Emergency .....	12	Speakers .....	46
End of Train .....	11	Static Display Flashers .....	12
Grade Crossing .....	19-21	Steam Sound Kit .....	40
Oscillating .....	10	Strobe Flashers .....	8-9
Strobe .....	8-9	Switch Machine—TORTOISE™ .....	34, 36
Flashing Rear End Device (FRED) .....	11	Switches	
Flickering Flame Circuit .....	See Arc Welder & FIRELITES™	Pushbutton .....	48
Fuse Holder .....	48	Reed .....	14
Gate Driver Circuit .....	21	Slide .....	47
<b>GRADE CROSSING CIRCUITS</b> .....	17-22	Toggle .....	47
Animators .....	22	Template, TORTOISE™ Drilling .....	36
Detection Circuits .....	17-19, 22	Time Delay Circuit .....	30
Alternating Flashers .....	20-21	Toggle Switches .....	47
Heat Shrink Tubing .....	47	<b>TORTOISE™</b> Switch Machine .....	34, 36
Hidden Accessory Switch .....	14	AC Adapter .....	36
Hookup Wire—Ultrafine .....	48	Drilling Template .....	36
Horn - Diesel .....	40	Track Power Adapters .....	13
<b>INSTALLATION</b> .....	6	Traffic Light Controller .....	41
<b>INTERFACE CIRCUITS</b> .....	37	<b>TRAIN CONTROL CIRCUITS</b> .....	29-31
Lamps .....	44-45	Train Detectors - Universal .....	23
Light Emitting Diodes (LEDs) .....	46	Tubing, Heat Shrink .....	47
<b>LIGHTING - LOCOMOTIVE &amp; VEHICLE</b> .....	8	<b>TURNOUT CONTROL</b> .....	32-36
<b>LIGHTING CIRCUITS &amp; SUPPLIES</b> .....	41-43	Ultrafine Hookup Wire .....	48
Logic Translator Circuit .....	37	Voltage Regulators .....	13, 38-39
Magnet for Reed Switch .....	14	Welding Circuit - Arc .....	42
Mars Lights .....	10	Wire, Ultrafine Hookup .....	48
<b>MITEY LITES™</b> .....	43-46	<b>WIRING</b> .....	6

<b>AR-1, AR-1CC</b> .....	29	<b>CF-1</b> .....	11	<b>EOT</b> .....	11	<b>ML-1, ML-2</b> .....	10	<b>SD-1 THRU SD-3</b> .....	26
<b>AR-2</b> .....	29	<b>CL-1, CL-2</b> .....	41	<b>ER-1, ER-2</b> .....	31	<b>OS-1, OS-2, OS-6</b> .....	47	<b>SNAPPER™</b> .....	32-33
<b>AS-1</b> .....	30	<b>DF-1, DF-2, DF-3</b> .....	18	<b>FF-1, FF-2, FF-3</b> .....	42	<b>PCMT</b> .....	48	<b>SMAIL™</b> .....	35
<b>AW-1, AW-2</b> .....	42	<b>DH-1, DH-2</b> .....	40	<b>FL1, FLO1</b> .....	8	<b>PB-1</b> .....	31	<b>SQ-8</b> .....	42
<b>BF-1, BF-2, BF-3</b> .....	12	<b>DL-1</b> .....	9	<b>FLA, FLN1, FLW</b> .....	9	<b>PL-8, PL-12</b> .....	41	<b>SS-1</b> .....	40
<b>BD-1, BD-1HD</b> .....	24	<b>DT-1, DT-2</b> .....	17	<b>FL-2, FL-2HD</b> .....	20	<b>PS-1 THRU PS-3</b> .....	39	<b>TC-1 THRU TC-4</b> .....	33
<b>BD-2, BD-2HD</b> .....	25	<b>DT-3</b> .....	18	<b>FL-3</b> .....	21	<b>RS-1, RS-2</b> .....	14	<b>TD-1</b> .....	30
<b>BD-3, BD-3HD</b> .....	25	<b>DT-4, DT-6</b> .....	23	<b>GA-1, GL-1</b> .....	22	<b>RSA, RTM</b> .....	36	<b>TL-1</b> .....	41
<b>BH-1 thru BH-6</b> .....	48	<b>DT-5</b> .....	22	<b>GD-1</b> .....	21	<b>SA-1, SA-2, SA-3</b> .....	28	<b>TORTOISE™</b> .....	34, 36
<b>BR-1, BR-2</b> .....	21	<b>EF-1</b> .....	12	<b>LT-1, LT-2</b> .....	37	<b>SL-1, SL-2, SL-3</b> .....	28	<b>TP-1, TP-2, TP-3</b> .....	13

# CIRCUITRON'S HISTORY

**CIRCUITRON** was formed in late 1977 when Steve Worack picked up a model railroading magazine (after a break in modeling for his college years) and thumbing through the pages, he realized that there were precious few (none) companies providing state of the art electronics for the industry. Steve had been a modeler from age 4 and had actively pursued the hobby up through high school. This experience, combined with his background in electronics led him to his decision to develop a line of products for the industry.

The initial product line was limited to roof-top locomotive strobes, a grade crossing detection unit (DT-1), grade crossing flasher (FL-2) and a hand-held throttle (later discontinued). Sales were limited to local hobby shops and flea markets. Revenues were meager, but the work was rewarding, and by the time the line was picked up by Wm. K. Walthers two years later, we had developed about 10 circuits and a dozen and a half accessories. National advertising in Model Railroader and Railroad Model Craftsman magazines had begun in 1978 and our sales were now nationwide.

In 1979, we attended our first national trade show, and although our exhibit was somewhat pathetic, we made up for it in enthusiasm. The line was well received and our orders, sales and recognition grew steadily throughout the early 80's. The **SNAPPER**<sup>™</sup> twin-coil switch machine power supply, automatic reverse circuits, block detectors and 3 more grade crossing detectors had now been added to the line. We now had six or seven domestic distributors and the letters from happy modelers using our products were now arriving on a regular basis.

In 1983, we made the big move out of the basement and into a tiny 1100 square feet of manufacturing space in Berwyn, IL. We purchased our first computer and for the first time, we employed assemblers and packers outside of family members. It was also around this time that the SCALE SCENICS Division was formed to market white metal kits of construction equipment.

In 1984, Steve designed and built the prototype of the TORTOISE<sup>™</sup> Slow Motion Switch Machine. Funding was secured through the Small Business Administration (SBA) to finance the cost of the

injection molding tooling and within a year, production had begun. The TORTOISE<sup>™</sup> is unique in the industry in being the first (and only) low-current, stall-motor mechanism which was specifically designed to be a model railroad switch machine. The new features of this machine resulted in a US patent for the design issued to Steve and **CIRCUITRON** the following year.

In 1988, **CIRCUITRON** was selected by Santa Fe Industries as the primary contractor to completely renovate the existing 3,000 square foot 'O' Scale layout at Chicago's Museum of Science and Industry. This layout was a favorite of museum visitors from all over the world, but decades of constant running and maintenance had taken their toll. This 2 year project included all new locomotives and rolling stock, completely refurbished scenery, many new structures, a complete new control console that simulated a modern dispatching tower complete with wheelchair accessible ramps, 3+ miles of new wiring, and a new computer controlled electronics system that was capable of operating all the train movements, signals and block controls for up to 6 independent trains. In addition, the operating hump yard (unique in its design) was completely redesigned and was also placed under computer control. Stock **CIRCUITRON** products were utilized as well as some custom built electronics. Sadly, this magnificent O scale layout was removed in 2004 to make room for an even more ambitious HO scale project.

By 1991, we had seriously outgrown our Berwyn facilities and we entered into an agreement with a long-time friend to jointly design and build a new 11,000 square foot industrial building to house both our businesses. Starting with sketches on a napkin, we refined and honed the design into something ideal for both our needs. Financing was secured and acting as our own general contractors, we brought the building in under budget. The building was completed in 8 months, and **CIRCUITRON** moved operations to Romeoville, IL in July of 1992. With its pillared entrance, split-faced block and two floors of light rose colored mirrored glass windows, it is, without a doubt, the prettiest building in the industrial park (see next page). We're *very* proud to be here.

## CIRCUITRON'S HISTORY, CONTINUED



This additional space allowed us to pursue a couple of other goals. In 1994, **CIRCUITRON** became an independent plastics processor when we purchased a brand new 55 ton injection molding machine, chiller and sprue grinder. The ability to mold our own parts for the TORTOISE™ has streamlined our production and allowed us to hold costs down. It also paved the way for a number of new plastics projects which have been and are currently under development.

The additional space in the new building also allowed us to get back into model building, something we had not had much opportunity to do during the previous few years. In 1995, **PROGRESSIVE MODEL DESIGN®** (PMD, a division of **CIRCUITRON, Inc.**) was formed to do custom layout and diorama building for businesses, museums and individuals. With some of the country's finest modelers and artists on staff, the quality of work coming out of our Romeoville studio is exceptional.

Also in 1995, **CIRCUITRON** introduced the MITEY LITES™ line of miniature lamps and LEDs. Working closely with our supplier overseas, we continue to expand the line and have developed the highest quality and widest range of sub-mini lamps and LEDs in the market.

Some of PMD's early projects included the 20 foot long display layout of **CIRCUITRON's** that has been a crowd pleaser at trade shows all over the country and a large overhead G Scale layout simulating Chicago's Elevated Transit system (the 'EL') and installed in the Big Downtown restaurant inside Chicago's famous Palmer House

Hilton. The custom painted structure for this layout was all hand-fabricated and assembled from extruded ABS plastic I-beams and other members and then hung from the ceiling of the restaurant. Two trains run around a double track continuous outside loop, stopping periodically while two other trains traverse point to point tracks across the width of the restaurant.

In July of 2000, our cabinet-maker partner dissolved his business and sold us his half of the building. After completely refurbishing the wood shop with all new equipment, PMD expanded to occupy the extra 5,200 square feet. We now had room to build substantial sized layouts for large homes, businesses and museums. We also purchased the equipment and installed a machine shop with CNC capability and a Laser Engraver/Cutter. You may visit us on the web at the PMD web-site at [www.ProgressiveModelDesign.com](http://www.ProgressiveModelDesign.com). Watch for photos of some of our projects in upcoming magazines.

Today, **CIRCUITRON** continues to expand our product lines as well as refining and improving existing products. We now have over 25 distributors in the U.S. and eight foreign countries and our products are commonly found in 1000's of hobby shops around the world. We now have close to 250 part numbers in our line (over 260 if you count **SCALE SCENICS**), and we are always working on new products soon to be released. As always, we remain committed to being the finest manufacturer of Model Railroad electronics and accessories, now and on into the 21st century.

## ABOUT THIS CATALOG

The **CIRCUITRON CATALOG AND APPLICATION BOOK** is divided into a number of sections by product type. This approach is intended to allow you to easily find similar type circuits in the same category and thereby make it simple to compare features. It also makes it easier for us to modify this catalog in the future by adding new products in specific categories. Certain products may not clearly fit into one or even *any* categories. Therefore, if you do not find what you are looking for, be sure to check the **INDEX** and the **ACCESSORIES** sections.

Most **CIRCUITRON** products have a model number as well as a part number. The model number is an alpha-numeric designator which typically gives a clue as to the nature of the circuit. Therefore, a **DT**-whatever is a type of *Detection System*, a **BD**-whatever is a type of *Block Detector* and the **ML-1** is one of our *Mars Lights*. After you become familiar with our product line, you may find it easier to refer to the products by model number. You will find, however, that many of our accessories such as lamps and LEDs do not have separate model numbers.

**CIRCUITRON** revises prices once a year. New price lists are issued around August or September to coincide with the release of Walthers' annual catalog. If your price list is out of date, you may request a new one by sending us a self-addressed stamped envelope.

We have attempted to make this **CATALOG AND APPLICATION BOOK** as comprehensive as possible. In the center of the catalog, you will find many pages of applications. These applications are only meant to be *suggestions*

of many of the ways that our circuits can be combined in order to achieve a certain result. It is not feasible, however, to cover *every* possible application of our numerous products, and we welcome your comments and questions regarding applications not mentioned here. Keep in mind that the applications in this catalog are *not* intended to be *detailed* wiring diagrams, and many of the connections may not be illustrated in order to keep the drawings simple and clear. Complete, detailed wiring diagrams as well as step-by-step instructions *are* provided with every product. In addition, you may find references throughout this catalog to product Application Notes. These Application Notes generally cover a very specific topic and provide much greater detail than is feasible to fit into the regular instruction sheet or this catalog. You may request a copy of an instruction sheet or Application Note by sending your request to **CIRCUITRON** along with one dollar (\$1.00) for handling and a stamped, self-addressed envelope. All application notes and instruction sheets are also available for free download in the **SUPPORT** section of our web site at:

**[www.Circuitron.com](http://www.Circuitron.com)**

You may come across products listed in this **CATALOG AND APPLICATION BOOK** that are not yet in production or that may (for some reason) be temporarily out of production. Please refer to the price list for further information. All current production items will be listed. If you do not find a catalog item on the price list, you may assume it is new and not yet available. Generally, the price list will contain information about the expected availability date on these items.

### NOTE

Every effort has been made to ensure that this **CATALOG AND APPLICATION BOOK** is accurate and informative. However, we reserve the right to change specifications and prices of our products at any time, without notice or obligation to previous purchasers, and revised products may deviate from the specifications contained herein.

# INSTALLING YOUR CIRCUITRON PRODUCTS

## GETTING STARTED



**PLEASE CAREFULLY READ THE ENTIRE INSTRUCTION SHEET INCLUDED WITH YOUR CIRCUITRON PRODUCT.**

## MOUNTING

There are 3 recommended methods which can be used to mount **CIRCUITRON's** electronic circuit boards.

- 1) All circuits with part numbers between 800-5000 and 800-5999 (5000 Series circuits) have circuit boards with a common dimension of 3" on their height. All these boards will easily snap into a section of our Printed Circuit Mounting Track (**PCMT**). See the **INDEX** for a listing. This is probably the most trouble-free and foolproof method, and the board remains unmodified should you have to move it or replace it.
- 2) Another method is to drill small holes through the corner mounting pads on the circuit board. Using standoffs (plastic is safest) to elevate the solder side of the board above the mounting surface, small screws can be inserted through the drilled holes, standoffs and into the mounting surface. Circuit boards 2" wide and under can be secured with only 2 screws on diagonal corners. Larger boards should have screws at all four corners.
- 3) A third choice is to use adhesive caulk or double-faced tape to secure the board to the mounting surface. This is probably the best choice for our smallest circuit boards, however, this method tends to be messy, and may make the board *very* difficult to remove should service ever be necessary. If you do choose this method, we recommend using a *tiny* dab (you do not need much) of RTV Silicone Caulk on each corner. *Do Not* use panel adhesive or other hard-setting glues. In all cases, make sure you keep the adhesive *off* the solder traces and limit it to just the corners. If you have used RTV, a razor knife will easily slice through the corner dabs and free the board, if necessary.

Lamps and LEDs will often need to be secured within a model. *Do Not* use ACC or epoxy. We recommend a *tiny* dab (you do not need much) of

RTV Silicone Caulk for this task. You may want to change the lamp later, and the RTV is easily carved away. Another product we have found very useful for this is *Instant Roadbed™* by AMI. A tiny piece of this stuff will stick just about anything to anything and never seems to dry out.

## WIRING

All **CIRCUITRON** 5000 Series circuit boards have male quick disconnect terminals and wire leads can be connected to them with .110" x .032" female solderless connectors (see **INDEX**) or by soldering them directly to the terminals on the printed circuit board (see **SOLDERING**). Since current requirements are generally low, wire leads can be light gauge (22 - 24 ga.). Stranded hookup wire is preferred to solid for almost all applications. If heavier wire is required, it will be mentioned in the instructions.

## POWER SOURCES

The power requirements of **CIRCUITRON** products vary from item to item depending upon the application. Be certain to *carefully* observe (and adhere to) the voltage ratings of a given circuit. Solid state electronics are terribly unforgiving when it comes to over-voltage. Components can be destroyed in an instant (far quicker than you can pull the plug). Damage caused by over-voltage is easily detected during repair and is *not* covered by **CIRCUITRON's** warranty.

### **WARNING:**

*Many newer power packs have accessory terminal voltages that exceed the 18 volt maximum rating of most CIRCUITRON products. This is because the pack manufacturers have attempted to make power packs suitable for **all** scales including 'G' with its much higher voltage requirements. Be sure to carefully measure the output of your power pack using a good quality voltmeter without a load applied and **before** you connect our circuit(s). Application of any voltage higher than a circuit's rating may damage or destroy the device and is **NOT** covered by your warranty.*

**CIRCUITRON** has a number of Power Supply Converter circuits (see **INDEX**) that will change your power pack output to a fixed DC voltage for those circuits that require it. In addition, Radio Shack, **CIRCUITRON** and other electronics suppliers sell AC to DC wall plug adapters of various voltages and current ratings that are low cost and ideal for many applications.

# SOLDERING

Many modelers are afraid to try soldering because they have had unsuccessful results in the past. Others avoid trying it because they have been *told* that it is difficult. Actually, good soldering of electronic connections is really quite easy... *if* you have the right equipment and adhere to a few simple rules:

- 1) Use a soldering iron (sometimes referred to as a soldering pencil) rated at 25 -40 watts. *DO NOT* try to use a large soldering gun.
- 2) Make sure you have a good mechanical connection between the parts you want to join.
- 3) Make sure that the parts to be soldered have a clean appearance free of corrosion and dirt. Most electronic parts are pre-tinned (tin plated) for easy soldering, but if you are soldering to brass or other bare metal parts, they should be cleaned by lightly sanding the areas to be soldered just before you apply the heat.
- 4) 'Tin' (apply solder to) bare wires before making your connection by applying the soldering iron to the exposed wire and then applying a small amount of solder to the wire after it has reached the melting point.
- 5) Use only electronics grade, rosin-core flux, 60/40 solder (see below for more information).
- 6) *Do not use acid type or paste fluxes* (this includes the TIX brand of liquid flux). Although they will solder well, the residue they leave on the joint is corrosive, cannot be effectively removed, and will eat away the base metal over time leaving a weakened or destroyed joint.
- 7) Apply a tiny amount of solder to the tip of the iron prior to placing it in contact with the joint. This will help the heat transfer and result in quicker work. The tip of the iron should be wiped clean (to remove burned flux) on a *damp* cellulose sponge after soldering a joint.
- 8) Place your soldering iron tip so that it firmly contacts the surface of *BOTH* parts to be joined. Try to use the side of the tip for better heat transfer rather than just the point. *Remember...* the soldering iron must be in contact with both parts to avoid bad joints.
- 9) Feed a small amount of solder into the joint after it has been heated to the melting point. *Apply solder to the joint! Do Not Apply the Solder to the Soldering Iron Tip!*
- 10) After the solder has flowed into the joint, remove the iron and allow the joint to cool undisturbed. Carefully inspect your work. A good solder connection should be shiny and should have crept up onto both parts creating a smooth fillet between them.

## CHEMISTRY

Electronics type solder is an alloy of Tin and Lead. The melting point of solders vary depending upon the percentage of the components used. Most commonly, 60% Tin and 40% Lead (known as 60/40 alloy) solder is used for electronics work because of its low melting point combined with good strength. 40/60 and 50/50 alloy are commonly found in hardware stores and are used for plumbing and radiator repairs. Their melting point is too high for electronics use and they should be avoided. "Eutectic" solder (63% Tin, 37% Lead) has the lowest melting point of standard Tin/Lead solders and although more costly than 60/40 alloy, it is sometimes used for delicate work. Silver Solder is still primarily a Tin/Lead alloy, but the addition of a small percentage of silver increases the strength dramatically. Wire solder for electronics is available in many diameters and contains a core of soldering flux composed of activated rosin. The purpose of the flux is to melt and flow across the parts to be soldered, cleaning the oxides off their surfaces in the process, and preventing new oxides from forming on the hot joint. Additional flux (beyond that contained in the wire solder) is usually not necessary or desired in electronics work. Tape solder (thin flat solder strips which are to be wrapped around a connection and heated with a match) are not appropriate for electronics work. Paste solder (not to be confused with the flux known as soldering paste) is comprised of microscopic solder balls suspended in flux to form a paste. Paste solder is widely used for surface-mount circuit boards.

## SOLDERING TIPS

- 1) When soldering directly to LEDs, lamps or other delicate components, use a pair of forceps or needle-nosed pliers as a heat sink to grip the lead(s) between the solder joint and the body of the component while soldering.
- 2) When soldering to the male PC tab terminals on **CIRCUITRON** products, apply only enough heat to get a good solder joint, and do not wiggle the terminal until the solder has cooled. These terminals solder very easily, but if too much heat is applied, or for too long, you may melt the solder on the other side of the board and loosen the terminal.



# LOCOMOTIVE, ROLLING STOCK & VEHICLE LIGHTING

## STROBE FLASHERS



A strobe flasher is designed to provide an intense, repeating, short-duration flash from its light source. The prototype utilizes strobes as warning beacons on locomotives, construction equipment, on tall

structures and a multitude of other places. **CIRCUITRON** manufactures a wide variety of strobes with colored Super-Bright Light Emitting Diodes or white incandescent lamps. These can be used for many different applications and in all scales. Most are 2.5 - 3.0 volt DC powered, however, a few have different voltage requirements. The flasher module is the smallest in the industry and can be easily fit into most powered models. All **CIRCUITRON** Strobe Flashers come fully assembled and tested. NOTE: Light Emitting Diodes (LEDs) emit light of one specific color only. They cannot be dyed or filtered to a different color. They also tend to be brightest when viewed head-on. When viewed from the side, the light emission is reduced, although the Hyper-Brite™ diffused-lens LEDs that **CIRCUITRON** uses are very bright from all angles. The White Strobes use clear incandescent lamps which you may dye to any color if desired. Please read the descriptions carefully before selecting an appropriate unit.

**NOTE:** THE SPECIFICATIONS FOR **CIRCUITRON** STROBE FLASHERS MAY HAVE CHANGED SINCE YOUR LAST CATALOG. A KEY INTEGRATED CIRCUIT WAS DISCONTINUED A FEW YEARS AGO AND WE HAVE HAD TO SUBSTITUTE A DIFFERENT DESIGN. PLEASE READ THE PRODUCT SPECIFICATIONS CAREFULLY.

### FL1 STROBE FLASHER - HO SCALE - COLORED

The **FL1** model of colored strobe offers the brightest flash in the industry. **CIRCUITRON** uses only the highest intensity, diffused-lens Light Emitting Diodes for a bright, wide-angle flash. The LED included with the **FL1** is a T-1

size (3mm diameter) and flashes approximately 60 times a minute. The 2.6—3.0 volt power for the **FL1** may be obtained from a single lithium type battery (even a tiny hearing aid or watch cell) or from one of **CIRCUITRON**'s Track Power Adapters. We do not recommend the use of Ni-Cad rechargeable batteries because the full charge voltage of 1.25 volts is too low to provide a bright flash. Current draw is amazingly low! A typical 3.0 volt watch cell will provide a day or two of *continuous flashing!* With a single lithium AA penlight cell, battery life is an incredible *3 months of continuous flashing!* Please note that these figures are for continuous flashing, and if you incorporate an On-Off switch (See our listing for Hidden Accessory Switches) in the model, life will

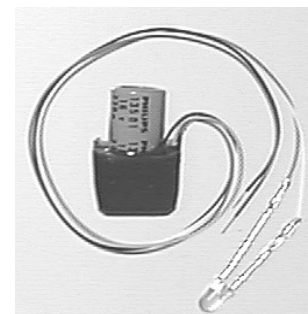

*Actual Size*

be extended accordingly. Under normal use, it is not unusual for a battery to last a number of months before replacement is necessary. Battery power is the preferred method (See our listing for Battery Holders) because it allows a locomotive to be parked on a siding with the strobe flashing and no power applied to the track. In addition, a small battery generally takes up less room in the locomotive than the electronics necessary to provide power from the track.

- 800-1001 FL1-O STROBE FLASHER, ORANGE, 3 MM (.12") LED
- 800-1002 FL1-R STROBE FLASHER, RED, 3 MM (.12") LED
- 800-1003 FL1-Y STROBE FLASHER, YELLOW, 3 MM (.12") LED

### FLO1 STROBE FLASHER - O SCALE - COLORED

The **CIRCUITRON FLO1** strobes are provided with a super bright, diffused-lens, T-1 ¾ size (5 mm diameter) LED, and the circuitry requires a 2.6 - 3.5 volt power source. As with the **FL1**, power can be obtained from batteries (use 2 alkaline or silver oxide cells in series or a single

## STROBE FLASHERS, CONT.

3 volt lithium type cell), or from one of **CIRCUITRON's** Track Power Adapters. The flasher module is the same size as the **FL1**.

- 800-1011 FLO1-O STROBE FLASHER, ORANGE,  
5 MM (.20") LED
- 800-1012 FLO1-R STROBE FLASHER, RED,  
5 MM (.20") LED
- 800-1013 FLO1-Y STROBE FLASHER, YELLOW,  
5 MM (.20") LED

### FLN1 STROBE FLASHER - N SCALE - COLORED

A remarkably bright Light Emitting Diode which is ideally suited for the N Scale Strobe has recently become available. The **FLN1** has been streamlined and with the new electronics, the result is a package trim enough to fit within virtually any N Scale dummy locomotive. The **FLN1** is available in super bright orange, red or yellow to suit various applications. The LED supplied with the **FLN1** has a square base .1" on a side, and a round dome which measures 2 mm diameter (.08"). This LED is not factory wired to the module's lead wires as with the **FL1** and **FLO1**. Instead, sub-miniature clips are wired onto the module lead wires. After the LED is mounted on the *outside* of the model, the square base of the LED can be painted a chrome silver, and the clips are then pushed onto the LED leads. The **FLN1** requires a 2.6–3.0 volt battery such as a lithium watch cell, the 'N' size Lithium cell or the **CIRCUITRON TP-1** may be used to power the **FLN1** from track power.

- 800-1021 FLN1-O STROBE FLASHER, ORANGE  
2 MM (.08") LED
- 800-1022 FLN1-R STROBE FLASHER, RED  
2 MM (.08") LED
- 800-1023 FLN1-Y STROBE FLASHER, YELLOW  
2 MM (.08") LED

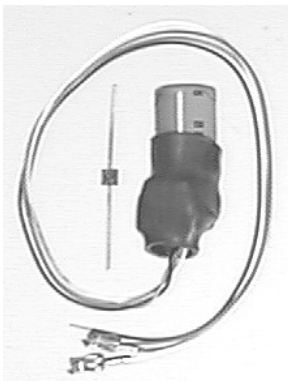

*Actual Size*

### FLW STROBE FLASHER - WHITE

The **CIRCUITRON FLW** series strobes provide a bright white flash from a small incandescent lamp (included). These units may be powered from batteries or by using one of our **TP-2** or **TP-3** Track Power Adapters. The lamps are prewired and only two wires need to be connected to the power source. All the White Strobes require 2.8–3.0 volts. Due to the fragile nature of the sub-miniature incandescent lamps, you must be careful to never apply voltage exceeding the unit's rating or destruction of the lamp may occur. The **FLW's** are the same physical size as the **FL1s**.

- Bright!**     ▶ 800-1031 FLW-1 STROBE FLASHER,  
WHITE, 1.4 MM LAMP
- Brighter!!** ▶ 800-1032 FLW-2 STROBE FLASHER,  
WHITE, 1.7 MM LAMP
- Brightest!!!** ▶ 800-1033 FLW-3 STROBE FLASHER,  
WHITE, 2.4 MM LAMP

### FLA AMTRAK STYLE WHITE STROBE FLASHER, TWIN LAMP

The **CIRCUITRON FLA** Amtrak Strobe Flasher is designed for mounting inside HO Scale or larger locomotives (due to the battery size, installation in a dummy loco may be necessary) and accurately simulates the action of the twin xenon strobes found on many of the current Amtrak locomotives. The **FLA** uses a 9 volt "transistor" style battery and will provide around 40 hours of flashing from an alkaline battery. Track power is not practical with this circuit unless you are utilizing command control in which case you can use a **PS-3** to convert the command system's track voltage to the 9 volts the **FLA** requires. The high output, accurately scaled subminiature lamps flash brilliantly around 50 times a minute. The **FLA** circuit board measures 1" square.

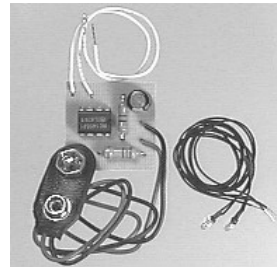

- 800-1100 FLA AMTRAK STYLE WHITE  
STROBE FLASHER

# OSCILLATING FLASHERS

## ML-1 & ML-2 MARS LIGHT FLASHERS

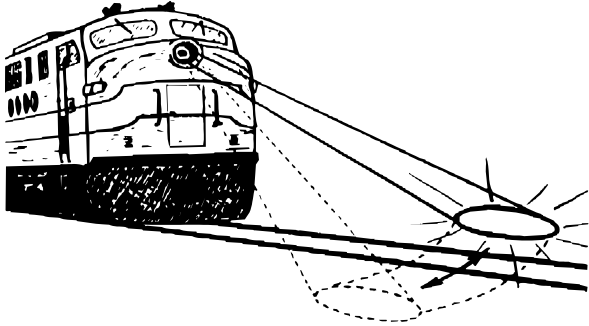

The **CIRCUITRON** Mars Light provides a very realistic simulation of the gyrating headlights used on many locomotives. The **ML-1** uses a special design, high intensity, lens-end, 4mm diameter, dual-filament lamp to cast the beam of light from one side of the track to the other. In a dark or semi-dark room, the effect is truly startling. The **ML-1** can be used in most any HO scale or larger locomotive with large headlight openings (such as EMD "E" or "F" units). The **ML-2** features two 1.7mm diameter, high intensity, lens-end lamps which can be mounted side by side in single or twin headlamp housings. The electronic control module is very compact, measuring only 0.6" x 0.4" x 1.1". This module is less than half the size of some competitive models. The Mars Light requires a 2.4 to 3.0 volt DC power source which may be obtained from batteries or by using the **CIRCUITRON TP-2** or **TP-3** Track Power Adapters. *NOTE: The TP-1 cannot be used to power the ML-1 or 2 due to the current draw of the high-intensity lamp(s). Battery operation may only be practical in a dummy or head-end car installation. Rechargeable Ni-Cad cells are not recommended (their voltage is too low). Rechargeable alkaline or lithium cells may be a good choice.*

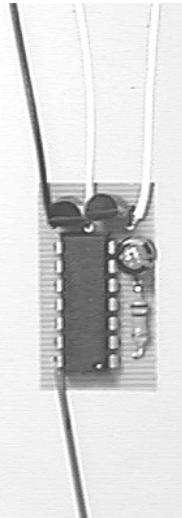

*Mars Light & Ditch Light Circuit shown Actual Size*

- 800-1500 ML-1 MARS LIGHT FLASHER, DUAL FILAMENT LAMP
- 800-1502 ML-2 MARS LIGHT FLASHER, 2 LAMP

## DL-1 OSCILLATING DITCH LIGHTS

The **DL-1** alternately flashes two 1.7mm diameter, high intensity, lens-end lamps (included) at a slow rate to simulate the pilot mounted safety lamps currently in use on most railroads. (Note: The flash rate of prototype Ditch Lights varies widely depending on the railroad. The flash rate of the **DL-1** is easily changed by replacing the one timing resistor on the circuit board. If room permits, a small adjustable trimmer can be wired in place of the fixed resistor to allow a wide range of adjustment of the rate. Send an SSAE and request Application Note AN1400-01 for more details.) With the addition of an optional DPST or DPDT switch (see ACCESSORIES), the **DL-1** can be easily bypassed to turn the ditch lights constantly on. The **DL-1** circuit board measures 0.6" x 0.4" x 1.1" and requires a 2.4 - 3.0 volt DC input which can be supplied by batteries or the **CIRCUITRON TP-2** or **TP-3** Track Power Adapters. *See NOTE in the ML-1 listing regarding batteries and Track Power Adapters.*

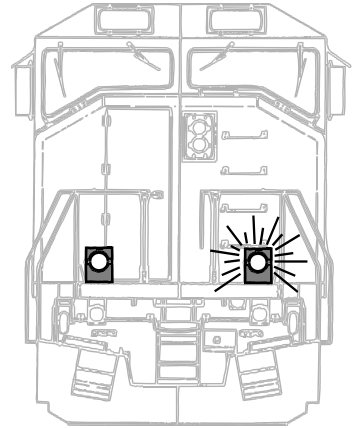

800-1400 DL-1 OSCILLATING DITCH LIGHTS

### TECHNI-TIP

EITHER THE MARS LIGHT OR DITCH LIGHT CIRCUITS MAY BE USED TO FLASH A SINGLE LAMP IF DESIRED. USE JUST ONE OUTPUT WIRE FOR THIS APPLICATION. IT IS ALSO POSSIBLE TO MAKE A SINGLE LAMP APPEAR TO OSCILLATE BY WIRING THE LAMP TO ONE OUTPUT IN THE NORMAL FASHION, BUT ADD A FIXED "BIAS" RESISTOR BETWEEN THE OUTPUT WIRE YOU ARE USING (WHITE) AND THE NEGATIVE (-) SIDE OF THE POWER SUPPLY. THIS WILL KEEP THE LAMP PARTIALLY ON BETWEEN FLASHES. YOU WILL NEED TO EXPERIMENT WITH RESISTOR VALUES TO ACHIEVE THE BRIGHTNESS AND EFFECT YOU DESIRE.

## END OF TRAIN FLASHERS

A number of years ago, when public awareness started compelling all the transportation industries to crack down on the safety of their equipment, the railroad industry responded by increasing the visibility of the front and rear of their trains. Locomotives were repainted with bold diagonal stripes across the nose and additional headlights,

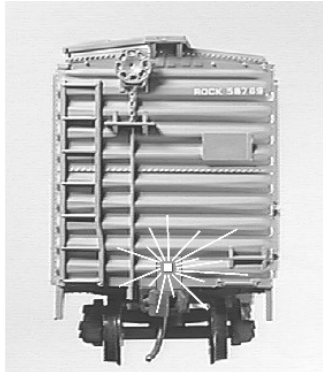

Mars lights and Ditch lights were added. Red or yellow lights were added to the caboose to increase visibility to the rear. Some railroads adopted flashing lights on their cabooses. These often took the form of one (or sometimes a pair of) rear-facing flashing light (s) mounted up under the roof overhang above the rear porch. When cutbacks forced the demise of the caboose (and the crews contained within), the railroads and the NTSB developed the specifications for a protection device to be mounted above the coupler of the final car in the train. Not popular with trainmen, these gadgets are known as End of Train (EOT) flashers or sometimes simply as FREDs (Flashing Rear End Device). **CIRCUITRON** manufactures two different circuits that can be used for this application. The main difference between the two circuits is the supply voltage required. Both units flash about once a second, however, the flash duration of the **CF-1** (on 1/2 second / off 1/2 second) is longer than the **EOT** (on 0.2 seconds / off 0.8 seconds). *Soldering is required with both kits.*

### CF-1 CABOOSE FLASHER

The **CIRCUITRON CF-1** is a low cost circuit which is designed to slowly flash a Light Emitting Diode, either red or yellow, on and off. The LED provided with the **CF-1** is easily mounted under the roof

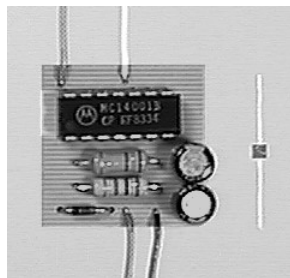

overhang on cabooses in HO scale or larger. It is also ideal for coupler mounting, if desired. The High Intensity, wide angle LED has a square base with a round dome lens protruding from it. If the base portion is painted black or silver, and the dome flattened slightly with a file, the resulting shape closely simulates a scale EOT device. The **CF-1** is designed to be powered by a 9 volt battery and will provide up to 100 hours of flashing from an alkaline type. Refer to the section on **HIDDEN ACCESSORY SWITCHES** for a listing of switches that can be used to control the **CF-1**. Because of the relatively high voltage requirements, powering the **CF-1** from track power is not practical, unless your layout utilizes command control. In this case, a **CIRCUITRON PS-3** Power Supply will convert the track voltage to 9 volts in order to power the **CF-1**. The **CF-1** measures 1" square x 3/8" high.

800-1200	CF-1	CABOOSE FLASHER WITH RED LED
800-1201	CF-1	CABOOSE FLASHER WITH YELLOW LED

### EOT END OF TRAIN FLASHER [FRED]

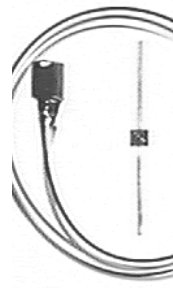

*Actual Size*

The **CIRCUITRON EOT** flasher includes the same LED as the **CF-1** above. Refer to the description of the **CF-1** regarding modifications to the LED which will result in a realistic HO scale device. After modifying, the LED is easily mounted on the coupler of any freight car. The electronic flasher module of the **EOT** is not much larger than the eraser end of a pencil and will easily fit in just about *any* scale model. The **EOT** requires a 3 volt power source which is most easily obtained from a pair of small batteries, or a single lithium watch cell (3 volts) although the **TP-1** Track Power Adapter can be used if the car is equipped with track power pickups. A pair of fine lead wires are provided for connecting the LED. Soldering is required.

800-1302	EOT-R	END OF TRAIN FLASHER W/ RED LIGHT
800-1303	EOT-Y	END OF TRAIN FLASHER W/ YELLOW LIGHT

## STATIC DISPLAY FLASHERS

The **CIRCUITRON** flashers described on the preceding pages are primarily designed to be self-contained within a moving model. The Static Display Flashers below are more appropriate for under-table mounting, although they can be contained within a structure if desired. *Note the power supply voltages listed for each product.* Most are designed to connect directly to the accessory terminals on a power pack, but some may require a power supply adapter.

**CAUTION:** See Warning on Page 6

### BF-1 BASIC FLASHER - LED

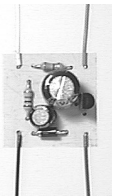

The **CIRCUITRON BF-1** is our simplest and least costly Light Emitting Diode flasher. It is designed to be powered by any 12 - 18 volt AC or DC power source and will flash any standard or high efficiency LED. The output is a short, high-intensity flash about once a second. The **BF-1** does *not* include the LED (see the **MITEY LITES™** section for a wide choice of LEDs). The **BF-1** circuit board measures 1" square.

800-1601 BF-1 BASIC FLASHER - LED

### BF-2 BASIC FLASHER - LAMP

The **BF-2** is a low cost universal flasher circuit that will flash any incandescent lamp or Light Emitting Diode load with a total current draw of 250 ma. or less. The **BF-2** can be powered by any 8 - 18 volt AC or DC power source. However, the DC load (lamps or LEDs) applied to the output *may* be powered by a *different* voltage source than the one powering the **BF-2**, if desired. It is even possible to power 2 or 3 *different* voltage lamps from the one **BF-2**, as long as the different power supplies have their negative (- or ground) connections wired together. The circuit board measures 1" x 1.5". The **BF-2** does not include any lamps or LEDs (see the **MITEY LITES™** section for a wide choice of lamps and LEDs).

800-1602 BF-2 BASIC FLASHER - LAMP

### BF-3 BASIC FLASHER - ADJUSTABLE

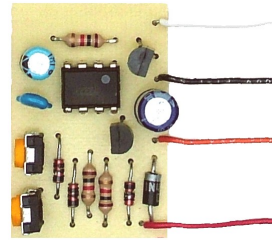

The **CIRCUITRON BF-3** is similar to the **BF-2** above and may be used for the same applications, but adds the flexibility of adjustable rate and duty cycle (the time on versus time off). Two tiny trimmer controls on the circuit board allow you to set the rate from one flash every 10 seconds up to dozens of flashes per second (note that the lamp will appear steady 'on' rather than flashing at high rates). The duty cycle is adjustable from 5% (a very short flash) up to 95%. All other specifications are the same as the **BF-2** above.

800-1603 BF-3 BASIC FLASHER - ADJUSTABLE

### EF-1 EMERGENCY FLASHERS

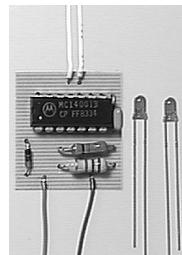

The **CIRCUITRON EF-1** Emergency Flashers are low cost circuits designed to alternately flash two Light Emitting Diodes at a constant rate. They are available with either .080" or .120" diameter LEDs in either Red or Yellow.

These units will add incredible action and excitement to emergency vehicles, barricades, signs, towers, etc. The **EF-1** features an ultra-simple four wire hookup and may be powered by a 9 volt battery or with a **PS-3** Power Supply Adapter (see **INDEX**). The **EF-1** measures 1" square.

800-3002 EF-1 WITH 3 MM (.12") RED LEDs  
800-3003 EF-1 W/ 3 MM (.12") YELLOW LEDs  
800-3022 EF-1 WITH 2 MM (.08") RED LEDs  
800-3023 EF-1 W/ 2 MM (.08") YELLOW LEDs

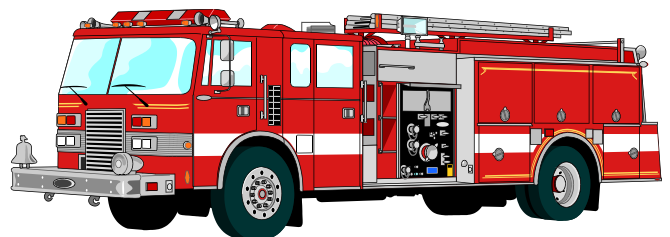

**NOTE:** For Higher Current Incandescent Lamp Flashers, Use an **FL-2** or **FL-3** (See Index)

## TRACK POWER ADAPTERS / CONSTANT LIGHTING

Adding on-board lighting accessories to a locomotive or piece of rolling stock is an exciting and rewarding project. Unfortunately, it is also one of the more difficult tasks that the electronics enthusiast will undertake. Besides the major problem of trying to find room inside a model that is crammed with a motor, flywheels, gear towers and weights, we have the additional aggravation of lamps and flasher circuits that generally require 1.5 to 3 volts being installed in a model where the available power (track voltage) runs up to 12 or 14 volts. To top it all, some of the power pack manufacturers have seen fit to release "universal" power packs that are capable of powering *all* scales including "G" with its 18-20 volt requirements. It must be quite entertaining when little Johnny accidentally (or perhaps on purpose!) cranks that throttle wide open, flips the pack switch to "G Gauge" and your brand new \$100.00 N Scale locomotive lets out a death wail, rockets off the end of the layout and buries itself two inches deep into the basement wall.

**CIRCUITRON** manufactures 3 different Track Power Adapters which can be used to power our low voltage flashers off of track power. The **TP-1** and **TP-3** are true voltage regulator circuits and derive their power directly from the track. They are ideal for use in models equipped with low-current 'can' motors or with no motors at all. The **TP-2** connects in series with the motor and the voltage dropped across the **TP-2**'s string of diodes can be used for powering lighting and flashers. See the **MITEY LITES™** section for sub-miniature lamps.

### TP-1 TRACK POWER ADAPTER

The **CIRCUITRON TP-1** is a miniature voltage regulator that can be used to power any **CIRCUITRON** Strobe Flasher (except the Amtrak Strobe - **FLA**) or the **EOT** Flasher from track power. In addition, the **TP-1** may be used as a constant lighting power source in unpowered rolling stock. No ballast lamps or motors are necessary. The **TP-1** has an output of 2.6 volts DC at a maximum of 50 ma. This is sufficient to power a number of strobe flashers, or to power two 1.5 volt micro-lamps in series. The **TP-1** has a bi-directional output

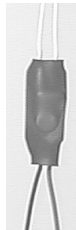

that is present with the train moving forward or backward. The **TP-1** may even be used with AC track power or command control systems. Slightly irregular flashing may occur with an AC input. The **TP-1** is extremely compact, measuring just 0.3" x 0.3" x 0.7".

800-2001 TP-1 TRACK POWER ADAPTER

### TP-2 TRACK POWER ADAPTER

The **CIRCUITRON TP-2** utilizes the time proven diode-drop design to provide an approximate 2.8–3.0 volt output to power **CIRCUITRON** Mars Lights, Ditch Lights, Strobe Flashers, etc. The **TP-2** also has directional 1.5 volt outputs that can be used to provide constant lighting using 1.5 volt micro-lamps (not included). When the **TP-2** is used to power the Mars Light or Ditch Light Flashers, the lamp(s) will be on only when the train is traveling forward. The **TP-2** is extremely compact, measuring only 0.2" x 0.4" x 1.0". The **TP-2** is usable with motors drawing up to one amp of current but may not deliver enough output when used with low current can and micro motors. For these applications, use a **TP-3** below.

800-2002 TP-2 TRACK POWER ADAPTER

### TP-3 TRACK POWER ADAPTER

The **CIRCUITRON TP-3** Track Power Adapter is a voltage regulator circuit which has an adjustable output that can be set by the modeler to supply either 1.5 or 3.0 volts DC. The **TP-3** is ideal for use as a constant lighting source in unpowered rolling stock. No ballast lamps or motors are required. The **TP-3** will also power the Mars Light and Ditch Light Flashers in models driven by low current can motors. The **TP-3** measures 1" x 1.5" x 0.5" and maximum current output is 0.5 amp. *NOTE: High track voltage will limit the output to 0.25 amp or less. In addition, the TP-3 will run very HOT at high current outputs. Do not mount in close proximity to plastic model shells.*

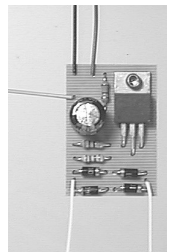

800-2003 TP-3 TRACK POWER ADAPTER

## HIDDEN ACCESSORY SWITCHES

There are many occasions when you may want to have the ability to turn an accessory mounted within a model **On** or **Off**. For example, battery powered devices should not be left running when the layout is not in operation. And there is no reason to have your passenger car string brightly illuminated during daylight hours. Wouldn't it be nice to be able to just wave your hand at the model and have the lights, for instance, come on? Well, with **CIRCUITRON's** Hidden Accessory Switches, you can do just that... almost.

The **CIRCUITRON RS-1** and **RS-2** provide a completely hidden switch for controlling Strobe Flashers, EOT Flashers, Mars or Ditch Lights, marker lamps, interior lights or other rolling stock electrical accessories. Both the **RS-1** and the **RS-2** utilize a subminiature reed switch and are turned On and Off simply by bringing an external magnet up to the outside of the car body in which they are mounted. The entire **RS-1** or **RS-2** kit is mounted inside the body and there are no external projections to detract from the appearance of the model. Both kits incorporate a latching mechanism so that the reed switch remains in the open or closed position until changed by the external magnet. The method by which this latching takes place differs between the two kits.

### RS-1 REED SWITCH KIT



*RS-1 shown actual size*

The **CIRCUITRON RS-1** is a two piece kit consisting of a subminiature reed switch measuring only 0.1" x 0.6" and a tiny bias magnet. When installing the **RS-1** kit, the reed switch is wired into one of the supply leads of the electrical device to be controlled. The reed switch is then fastened

to the inside of the locomotive or car shell (away from magnetic materials such as the motor) with ACC or epoxy cement. The bias magnet is then placed in position following the simple instructions packed with the **RS-1** and glued in place. When the magnet is properly

located, its magnetic flux will be strong enough to hold the reed switch closed once it has been closed by an External Magnet (not included), but not strong enough to close the reed switch on its own. This results in the latching On and Off action. The **RS-1** can control up to 0.25 amps.

800-9100 EXTERNAL MAGNET

800-9101 RS-1 REED SWITCH KIT

### RS-2 REED SWITCH KIT

The **RS-2** is a specially designed self-latching reed switch. It requires no bias magnet and no adjustments to perform the same function as the **RS-1**. The **RS-2** measures 0.75" x 0.1" and can control up to 0.25 amps.

800-9100 EXTERNAL MAGNET

800-9102 RS-2 REED SWITCH KIT

**NOTE:** If you do not need a completely hidden switch, check out our super-miniature Slide Switches listed in the **ACCESSORIES** section.



**TECHNI-TIP** ALTHOUGH MOST APPLICATIONS FOR THE REED SWITCH KITS WILL ALLOW YOU TO MANUALLY BRING THE EXTERNAL MAGNET UP TO THE CAR OR LOCOMOTIVE, IN SOME CASES YOU MAY WANT TO HAVE YOUR HIDDEN REED SWITCHES AUTOMATICALLY OPERATED. THE REED SWITCHES WILL NEED TO BE MOUNTED VERTICALLY AGAINST THE SIDE OF THE CAR(S) BODY, AND THE ACTUATING MAGNET WILL NEED TO BE ORIENTED WITH ITS POLES ALIGNED VERTICALLY (NORTH *OVER* SOUTH OR VICE VERSA). IF YOU ARE ATTEMPTING TO AUTOMATICALLY ACTUATE A STRING OF PASSENGER CARS, FOR INSTANCE, ALL THE **REED SWITCHES** MUST BE MOUNTED AT EXACTLY THE SAME POSITION IN EACH CAR TO ENSURE PROPER ACTUATION. YOU WILL ALSO NEED TO MAKE SURE THAT ALL THE BIAS MAGNETS ARE MAGNETICALLY ORIENTED THE SAME WAY. THEN, RUNNING THE TRAIN PAST A STATIONARY EXTERNAL MAGNET WILL TURN ON THE ENTIRE STRING OF CARS. A SECOND MAGNET ORIENTED THE OPPOSITE WAY WILL TURN THEM ALL OFF.

# DETECTION SYSTEMS

## AN OVERVIEW

**de•tec'tion** (di-tek'shən) *n.* find out; discover (what is hidden or obscure).

Model railroaders define detection as the ability to know the location on a layout of a locomotive or piece of rolling stock, even when that equipment is hidden from view. Early forms of detection (electrical, not electronic) relied on large relays with sensitive coils. Power was routed to the track through the relay coil, and when a locomotive was in the section of track wired to the coil, the relay would pull in. This system worked effectively for the 'O' Scale and larger equipment in use in those days, but as HO scale became popular, with its smaller motors and much lower current draw, this *series relay* form of detection lost favor.

Another early form of detection was the Track Switch. Used extensively by Lionel, American Flyer and others, it consisted of a spring loaded contact assembly which was activated by the weight of the passing train. Although adequate for the simple signal and crossing gate needs of those tinsplate layouts, they were not very stable, and are not practical for a layout where the track is fixed to the roadbed.

Fortunately, about the same time that 2-rail DC powered HO scale layouts started to replace the larger scales, transistors were invented, and these led to the development of true *electronic* detection. The Twin-T circuit, designed by Lynn Westcott was simple, sensitive and effective, and it found immediate favor with modelers. The Twin-T circuit was sensitive enough that rolling stock could now be detected if a resistor was placed across the insulated wheelsets. Variations of the Twin-T circuit are still being marketed today (but not by **CIRCUITRON**).

After low cost integrated circuits (ICs) with hundreds and sometimes thousands of transistors on one chip were developed, a number of manufacturers started utilizing this new technology to provide sophisticated detection for model railroads. **CIRCUITRON** pioneered the use of integrated circuits combined with tiny optical sensors for Opto-electronic train detection in any scale. ICs have also been used to replace the discrete

transistors of the Twin-T circuit, and they offer greater sensitivity and more stability in this application. Finally, ICs have been used for "check-in / check-out" logic circuitry (memory), usually activated by reed switches or track contacts, but this concept has a number of big disadvantages, and it has never been very popular.

On the following page you will find a chart comparing the pros and cons of the various common forms of model railroad detection. No one form is perfect for all applications, and that is the reason that **CIRCUITRON** manufactures *both* Current-Sensing and Opto-Electronic detectors.

For most applications, the Opto-Electronic circuits are the easiest to install, particularly when the track is already in place and wired. Our Opto-Sensors are extremely tiny (0.18" diameter) and easily fit between the ties in HO scale. By shaving away part of two adjoining ties, they can be used in the smaller scales. It is unnecessary to remove or alter any existing trackage, and in most cases, no loss of performance will result even if the Opto-Sensors are *covered* with a thin layer of ballast. The associated circuitry is highly sophisticated and sensitive and will operate properly under extremely low levels of room light. All our Opto-Electronic circuits contain adjustment controls to set the sensitivity of the circuits to your existing room light.

When it is desired to operate under varying lighting conditions, or in total darkness, the Current-Sensing type of detector is the most practical. It is generally less costly, per block, than the optical system as well. However, wiring is somewhat more complicated and each piece of (unlighted) rolling stock will need to be modified in order for the electronics to detect it. Metal wheelsets will need to be installed, and resistors or resistance paint will have to be applied across the axle insulator. These added costs must be considered when comparing systems.



## COMPARISON OF COMMON DETECTION SYSTEMS

DETECTION TYPE	ADVANTAGES	DISADVANTAGES
SERIES RELAY - A sensitive relay is connected in series between the power pack and the track. When power is applied to a block, and a locomotive is in the block, drawing current from the power pack, the relay will pull in. The relay contacts can be used for control of signals, etc.	<ol style="list-style-type: none"> <li>1) Simple</li> </ol>	<ol style="list-style-type: none"> <li>1) Detects only powered locomotives &amp; equipment</li> <li>2) Power must be supplied to the block</li> <li>3) Causes power loss to track</li> <li>4) High Cost for sensitive enough relays</li> </ol>
TRACK SWITCH - A leaf switch or spring loaded trackside addition is activated by train weight or by a "shoe" mounted on the locomotive.	<ol style="list-style-type: none"> <li>1) Simple</li> <li>2) Low Cost</li> </ol>	<ol style="list-style-type: none"> <li>1) Unreliable</li> <li>2) Unightly</li> <li>3) May require locomotive modification</li> <li>4) May not detect light weight rolling stock</li> <li>5) May cause derailments</li> </ol>
REED SWITCH - Magnetic reed switches are buried beneath the track. Magnets, mounted underneath the locomotive or piece of rolling stock, activate the reed switches as they pass over them. Momentary nature of reed switches requires logic circuits to maintain the output 'on' and to control external devices.	<ol style="list-style-type: none"> <li>1) Reliable</li> <li>2) Independent of track power</li> </ol>	<ol style="list-style-type: none"> <li>1) Basic connections are <i>not</i> bi-directional</li> <li>2) Locating reed switches requires disrupting existing trackage and/or ballast</li> <li>3) Magnets are unightly</li> <li>4) Magnets pick up ferrous debris from track</li> <li>5) Modification of rolling stock is necessary (magnets)</li> </ol>
CURRENT SENSING - The current flowing through a locomotive or lighted car in an isolated section of track (block) is detected by sensitive solid-state circuitry and provides an output. Unpowered rolling stock can be detected by providing a current path between the rails such as resistors or resistance paint across the axle.	<ol style="list-style-type: none"> <li>1) Track power does <i>not</i> need to be applied to the block to provide detection</li> <li>2) Extremely sensitive</li> <li>3) Works for most any AC or DC form of track power including command control</li> <li>4) Bi-directional</li> <li>5) Any scale</li> <li>6) Will operate in total darkness</li> </ol>	<ol style="list-style-type: none"> <li>1) May disrupt sound systems</li> <li>2) Rolling stock must be modified to provide reliable detection</li> <li>3) Circuits without sensitivity adjustments may "false trigger" during humid conditions</li> </ol>
OPTO-ELECTRONIC - Light sensitive photocells are mounted between the rails. When a passing train shades the photocell from the ambient room light, the associated circuitry is activated for the given application. An alternative of this system utilizes phototransistors and an infrared light source.	<ol style="list-style-type: none"> <li>1) No unightly additions to track</li> <li>2) No disruption of existing trackage or ballast</li> <li>3) Detects all rolling stock with no modifications</li> <li>4) Independent of track power</li> <li>5) Any scale</li> <li>6) Bi-directional</li> <li>7) Easy installation</li> </ol>	<ol style="list-style-type: none"> <li>1) Will not operate in total darkness</li> <li>2) Large changes in room lighting may require re-adjustment of the circuitry</li> </ol>

All **CIRCUITRON** detection systems have outputs that provide a connection to 'negative' (- or ground) when the train is detected. In this way, DC accessories or lamps of varying voltages (with different power supplies) can *all* be controlled by the output. You may view the **CIRCUITRON** output as a simple ON-OFF switch that connects the output terminal to ground (-) when it is on. When it is off, the output 'floats' (connects to nothing). We purposely

chose this configuration so that the outputs are directly compatible with all computer systems and may be easily interfaced. Some other manufacturers have chosen to provide a 'positive' voltage from their outputs. This is a less flexible approach, and these circuits are not directly compatible with **CIRCUITRON** products. However, we do offer Logic Translator circuits which may allow some of the other brands to work with our devices.

# GRADE CROSSING CIRCUITS

**DCC COMPATIBILITY NOTE:** SOME OF **CIRCUITRON**'S DETECTION SYSTEMS WERE DESIGNED *BEFORE* THE ADVENT OF **DCC** (**D**IGITAL **C**OMMAND **C**ONTROL). THESE CIRCUITS REQUIRE DC TRACK POLARITY FOR PROPER OPERATION. PLEASE READ THE DESCRIPTIONS OF THE PRODUCTS CAREFULLY BEFORE CHOOSING THE MOST APPROPRIATE CIRCUITS FOR YOUR PARTICULAR APPLICATION.

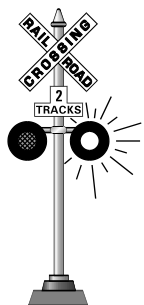

**CIRCUITRON** manufactures a complete line of Detection Systems, Alternating Lamp Flashers and Bell Ringer circuits specifically designed for grade crossings. The detection systems rely on our proven Current Sensing or Opto-Electronic design and are available for either single direction or bi-directional traffic.

**NOTE:** The **DT-1**, **DT-2**, and **DT-3** Detection Systems do *not* have provisions for flashing lamps. They must be used with an Alternating Flasher such as the **FL-2** or **FL-3**. The **DF-1**, **DF-2** and **DF-3** Detector/Flasher circuits include the alternating flasher on the same circuit board.

## DT-1 GRADE CROSSING DETECTOR

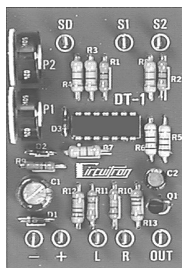

The **CIRCUITRON DT-1** is a bi-directional detection circuit designed *for DC track power* that provides an output whenever one of its Opto-Sensors is covered by a piece of rolling stock. Absolutely no modifications to the rolling stock are necessary. 4 Opto-

Sensors are provided, 2 of which are used for each direction of travel. The two Opto-Sensors for each direction are wired in series, and a single sensitivity control for each direction adjusts the pair to compensate for varying levels of room light. The **DT-1** connects to the track to determine track polarity and activates only the Opto-Sensor set for that direction of travel. This ensures that the output of the **DT-1** turns off just after the last car clears the crossing *in either direction of travel*. The **DT-1** circuit board measures 2" x 3" and requires a 10 - 18 volt AC or DC input for proper operation, however, the unit will be

**NOTE:** If the **DT-1** or **DT-2** are installed on layouts using Command Control, the train direction sensing feature is defeated, and a manual panel switch must be used to establish the direction of travel prior to a train arriving at the crossing. Although this is somewhat clumsy, it is not much different from the prototype where a dispatcher must set the travel direction of signals on bi-directional trackage.

slightly more stable and easy to adjust if a filtered DC source is used (see **POWER SUPPLIES**). The output of the **DT-1** provides a connection to the common or ground (-) side of the circuit and is capable of controlling DC powered loads up to 250 ma. Please note that the **DT-1** has no means of detecting a short train or single locomotive if it falls between the Opto-Sensors., so that while the train is *between* the sensors, the output will be off. An optional 3rd sensor (see **ACCESSORIES** section) can be added to each side, if desired, and this will cut the minimum train length in half. However, if you desire the utmost in realism, or if you run an abundance of short trains, consider using the **DT-2** (below) instead. Please see note regarding flashers above.

800-5201 DT-1 GRADE CROSSING  
DETECTOR—BI-DIRECTIONAL

## DT-2 GRADE CROSSING DETECTOR - FULL LOGIC

**CIRCUITRON** designed the **DT-2** to be the most advanced *DC track power* grade crossing detection circuit available at any cost. It is completely independent of train length and it will duplicate prototype grade crossing action for a single locomotive or a 100 car train. The **DT-2** is completely bi-directional and includes the 4 Opto-Sensors required for a normal installation. The integrated circuit memory on the **DT-2** does not require that a sensor remain covered in order to provide an output; the sophisticated circuitry will always maintain the output 'ON' for any length approaching train just until the

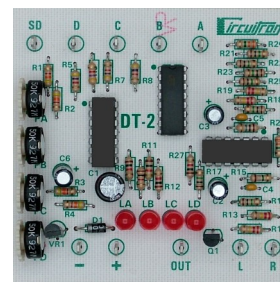

## GRADE CROSSING DETECTION CIRCUITS, CONT.

last car clears the crossing. If a train should stop short of a crossing and then back away, the **DT-2** will detect that, also, and turn the output 'OFF'. The **DT-2** is fully assembled on a 3" x 3" printed circuit board and will operate equally well from any 10-18 volt AC or DC power source. The output of the **DT-2** provides a connection to the common or ground (-) side of the circuit and is capable of controlling DC powered loads up to 250 ma. Although the **DT-2** is one of our more costly circuits, it is still an *outstanding* value for serious model railroaders who demand nothing less than the ultimate in realism for their layouts. Please see note regarding flashers above.

800-5202 DT-2 GRADE CROSSING  
DETECTOR - BI-DIRECTIONAL FULL LOGIC

### DT-3 GRADE CROSSING DETECTION CIRCUIT - SINGLE DIRECTION

The **CIRCUITRON DT-3** Single Direction Grade Crossing Detection Circuit utilizes our proven Opto-Electronic Detection and will provide accurate grade crossing action for a single locomotive or a 100 car train. There are absolutely no modifications to rolling stock necessary. The **DT-3** is

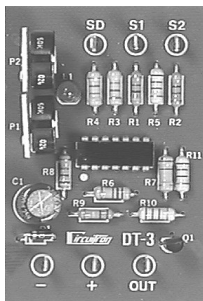

completely independent of the track power and is compatible with AC or DC track power as well as command control systems (DCC). It may be used for any scale. The **DT-3** may be powered from any 10 - 18 volt AC or DC supply and will control any **CIRCUITRON** Alternating Flasher, Bell Ringer Circuit, External Relay, etc. The **DT-3** is constructed on a 2" x 3" printed circuit board.

800-5203 DT-3 GRADE CROSSING DETECTION  
CIRCUIT- SINGLE DIRECTION

### DT-4 ROLLING STOCK DETECTOR

Although not designed specifically for grade crossings, the **DT-4** may be used to advantage in certain situations. [See listing on Page 23]

### DT-5 GRADE CROSSING DETECTOR

[See Full Descriptive Listing on  
Page 22]

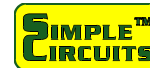

### DF-1 GRADE CROSSING DETECTOR WITH FLASHER

The **CIRCUITRON DF-1** is a full performance, *single direction* grade crossing detection circuit and alternating flasher on one circuit board. The **DF-1** is remarkably low cost considering the outstanding performance it delivers and is the ideal setup for the modeler who does not require the bi-directional capabilities of the **DT-1** or **DT-2**. The **DF-1** utilizes our proven

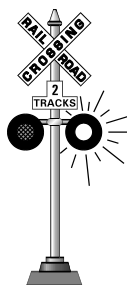

Opto-Electronic Detection and will provide

accurate grade crossing action for a single locomotive or a 100 car train. There are absolutely no modifications to rolling stock necessary. The **DF-1** is completely independent of the track power and is compatible with AC or DC track power as well as command control systems (DCC). It may be used with any scale and requires a 10 - 18 volt AC or DC power source. The flasher section of the **DF-1** has the same specifications as our **FL-2** and can power two 250 milliamp loads (approximately 4 grain of wheat lamps or 10 LEDs per side). Other **CIRCUITRON** Detection circuits such as the **DT-1**, **DT-2** or **DT-3** below can be easily connected to provide control of the flasher section when detection on parallel tracks is desired. An Accessory **OUT** terminal is provided which will provide a **GROUND [-]** output whenever a train is detected. This terminal may be used to control Bells, Gates, etc. through the use of other circuitry such as the **BR-1**, **BR-2**, **BR-3**, **GD-1** and **ER-1/ER-2** boards. The **DF-1** printed circuit board measures 3" x 3".

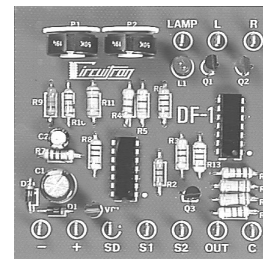

800-5250 DF-1 GRADE CROSSING DETECTOR  
AND FLASHER - SINGLE  
DIRECTION

## GRADE CROSSING DETECTION CIRCUITS, CONT.

### DF-2 MICRO-CONTROLLER GRADE CROSSING DETECTOR W/ FLASHER & GATE DRIVER—OPTICAL DETECTION

[CHECK PRICE LIST FOR AVAILABILITY]

The **DF-2** is a bi-directional Microprocessor controlled circuit which utilizes our proven Opto-Electronic detection. Completely independent of track power, the **DF-2** may be used in all scales and with all forms of track power including AC and Command Control (DCC). No modifications to rolling stock are necessary. The **DF-2** automatically senses train direction and utilizing microprocessor controlled logic and timers, sets the outputs properly for both directions of travel. Alternating lamp flasher outputs are provided which can control up to 250 ma. on each side. An accessory OUT terminal is provided to control relays, Bell Ringers, etc. This terminal can also control up to 250 ma. A gate drive output is provided which will directly drive up to 2 **TORTOISE™** Slow Motion Switch Machines configured as gate mechanism drivers. Gate Motor Speed is adjustable. The **DF-2** is mounted on a 3" x 3" Printed Circuit Board and requires 10-18 volts DC for the circuit power.

800-5252 DF-2 MICRO-CONTROLLER GRADE CROSSING DETECTOR WITH FLASHER & GATE DRIVER - OPTICAL DETECTION

### DF-3 MICRO-CONTROLLER GRADE CROSSING DETECTOR W/ FLASHER & GATE DRIVER—AC OR DCC POWER

[CHECK PRICE LIST FOR AVAILABILITY]

The **DF-3** is a bi-directional Microprocessor controlled circuit which utilizes our proven digital current sensing detection. It can operate in total darkness. The **DF-3** may be used in all scales utilizing AC or Command Control (DCC) track power. *It may not operate properly with conventional DC track power packs.* The trackage in the vicinity of the grade crossing will need to be isolated into Eastbound and Westbound "Approach" sections as well as a short section across the

grade crossing (the "Island" section), a total of three isolated sections. The detection on the **DF-3** does *NOT* introduce a significant voltage drop to the track. Powered Locomotives and lighted rolling stock will automatically be detected. Metal wheelsets with resistors will need to be installed on unpowered rolling stock if it is desired to detect them. The **DF-3** automatically senses train direction and utilizing microprocessor controlled logic and timers, sets the outputs properly for both directions of travel. Alternating lamp flasher outputs are provided which can control up to 250 ma. on each side. An accessory OUT terminal is provided to control relays, Bell Ringers, etc. This terminal can also control up to 250 ma. A gate drive output is provided which will directly drive up to 2 **TORTOISE™** Slow Motion Switch Machines configured as gate mechanism drivers. Gate Motor Speed is adjustable. The **DF-3** is mounted on a 3" x 3" Printed Circuit Board and requires 10-18 volts DC for the circuit power.

800-5253 DF-3 MICRO-CONTROLLER GRADE CROSSING DETECTOR WITH FLASHER & GATE DRIVER - AC OR DCC TRACK POWER

## ALTERNATING FLASHERS

With the exception of the **DF-1**, **DF-2** & **DF-3**, **CIRCUITRON's** Grade Crossing Detection circuits do not have any provision for flashing lamps. The outputs from these circuits are used to control a separate Alternating Flasher such as the ones listed below. **CIRCUITRON's** Alternating Flashers utilize control terminals

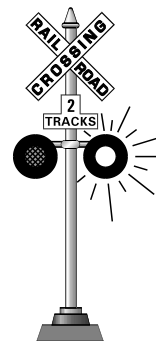

to turn the flashing action on and off. The tiny amount of current required by this control leaves virtually the entire current capacity of the detection circuit untouched, and available for driving other devices. Although primarily designed for grade crossings, these Alternating Flasher circuits are also handy for headlamps or warning lights on police or emergency

# ALTERNATING FLASHERS, CONT.

vehicles, or to provide an eye-catching display on signs, billboards, towers, etc. All of CIRCUITRON's Alternating Flashers can be used to power incandescent lamps or Light Emitting Diodes (LEDs). They require a 10 - 18 volt AC or DC input; however, maximum performance will be achieved when used with a DC power supply. All the circuits use low power CMOS integrated circuits for high reliability and constant flash rate independent of the load. This rate is fixed at the factory at about 50 oscillations per minute, but the rate can be easily changed for special applications (consult the **CIRCUITRON** factory).



**NOTE:** All **CIRCUITRON** FL Series Alternating Flashers may be used with 3-rail track power (either AC or DC) *without* any Detection circuit, as long as they are powered by a *separate* DC power source. This application is covered in the **APPLICATIONS** section of this catalog, or request Application Note **AN5100-1** for more detailed information.

**CAUTION:** When **CIRCUITRON**'s Alternating Flashers are used with LED-type crossbuck signals, the signals *must* be wired with a 'common anode' configuration. This wiring style is the most frequently used by the various manufacturers, but it is *not* universal. You can test your crossbuck signals for compatibility *before connecting them to our circuits* with a 9 volt battery and a 1,000 ohm, ½ watt resistor (your signal may already include a resistor; if so, use that). Your signal should have 3 wires coming out of it, or perhaps 2 wires and the mast as a third. Connect one side of the resistor to the common wire or mast. Connect the other side of the resistor to the positive (+) side of the 9 volt battery. Touch each of the remaining wires (one at a time) to the negative (-) side of the battery. Each lamp should light in turn.

## FL-2 ALTERNATING FLASHER

The **CIRCUITRON** FL-2 is designed to be controlled by the output from one of our Grade Crossing Detection circuits. The **FL-2** may also be easily wired for continuous flashing or for manual control with a panel switch, if desired. Only one **FL-2** is needed per road crossing regardless of the number of tracks (each with their own Detection circuit) at the crossing. The FL-2 will power incandescent lamps or Light Emitting Diodes (with proper current limiting resistors). The maximum load that may be applied to each output is 250 ma. This is sufficient to flash 3 or 4 standard grain of wheat lamps or 10 - 15 LEDs per side. The current draw of grain of wheat lamps varies widely from one manufacturer to the next. Typically, they will be in the 50-75 ma. per bulb range. If you are not sure, check them with an ammeter. The outputs of the **FL-2** are *not* protected against over-current or short circuit conditions, and connecting too many lamps to the outputs will likely damage the circuit. This is not covered by warranty. The **FL-2** is constructed on a 1.5" x 3" printed circuit board.

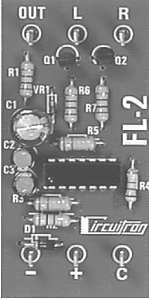

800-5102 FL-2 ALTERNATING FLASHER

## FL-2HD HEAVY DUTY ALTERNATING FLASHER

The **FL-2HD** is identical to the standard **FL-2** with the exception of the output load capacity. Heavy duty output transistors on the **FL-2HD** raise the maximum load to 500 ma. per side. This circuit is recommended for boulevard crossing signals with their multiple lights and also for signals in the larger scales which draw more current than the standard **FL-2** can supply.

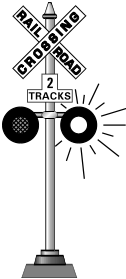

800-5122 FL-2HD HEAVY DUTY  
ALTERNATING FLASHER

## ALTERNATING FLASHERS, CONT.

### FL-3 ALTERNATING FLASHER - 3 OUTPUT

The **CIRCUITRON FL-3** is a complete solid state flasher with three independent outputs that can be used to alternately flash sets of incandescent lamps or LEDs at three *separate* locations. Three control terminals are provided for use with **CIRCUITRON** Detection circuits, and this allows individual control of each of the locations. Alternately, the three control terminals may be connected together for increased current capability to provide a heavy duty flasher with a maximum capacity of 750 ma. on each side. The **FL-3** contains on-board regulation to allow the unit to be powered by 10-18 volts AC or DC. Best performance will be achieved, however, when a DC power supply is used. The **FL-3** measures 3" x 3".

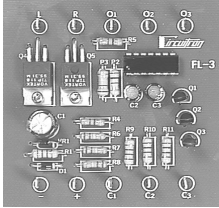

800-5103 FL-3 ALTERNATING FLASHER—3 OUTPUT

## CROSSING GATE DRIVER

### GD-1 GATE DRIVER CIRCUIT



The **CIRCUITRON** Gate Driver Circuit may be used in conjunction with any of our Detection Circuits and Alternating Flashers. It is designed to directly drive up to 2 **CIRCUITRON** Tortoise™ Slow Motion Switch Machines when used as the actuator(s) for Grade Crossing Gates. The speed of motion is fully adjustable. Control of the flasher circuit is handled by the **GD-1** and an adjustable timer will hold the flashers ON while the gate rises. The Gate Driver Circuit is mounted on a 2" x 3" printed circuit board and requires 10-18 volts DC.

800-5550 GD-1 GATE DRIVER CIRCUIT

**NOTE:** For the TORTOISE™ Slow Motion Switch Machine and our Remote Signal Activator mechanism, see Pages 34-36.

## BELL CIRCUITS

### BR-1 BELL RINGER CIRCUIT W/ BELL

The **CIRCUITRON BR-1** Bell Ringer is ideal for use with any of our grade crossing systems. The **BR-1** is designed to power a standard mechanical doorbell (a 2½" doorbell is included). This combination is less costly than digital recordings and yet provides a far better sound quality than most all electronic bell simulator circuits. The **BR-1** is quite sophisticated and provides control of both the ringing rate and the strike force. In this way, the sound produced by the bell can be easily changed to simulate grade crossing, locomotive or factory bells. The **BR-1** is automatically activated by any **CIRCUITRON** Detection Circuit. The **BR-1** may also be easily wired for manual operation with a panel pushbutton or switch, if desired. The **BR-1** circuit board measures 2" x 3" and requires a 12 - 18 volt AC or DC input for proper operation. **Warning:** *The **BR-1** is NOT designed for continuous operation. If extended ringing periods are anticipated, use only a REGULATED 12 volt DC source to minimize heat buildup in the **BR-1** components. Any input voltage in excess of 12 volts must be dissipated as heat on the circuit board. If this heat is allowed to build up (from extended or continuous use), damage to components may occur.*

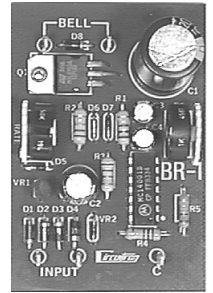

**CAUTION:** See Power Supply Warning on Page 6

800-5700 BR-1 BELL RINGER WITH BELL

### BR-2 BELL RINGER CIRCUIT W/O BELL

The **BR-2** Bell Ringer is identical to the **BR-1** without the inclusion of the doorbell. You may purchase any standard doorbell at a hardware store or home center and this will usually be a little less costly than the combination package of the **BR-1**. You may also be able to find a larger diameter bell than the 2½" unit packaged with the **BR-1**. Trine is one manufacturer that offers a 4" diameter gong and this bell sounds great with the **BR-2**. Larger diameters yield lower tones that will more exactly simulate the prototype.

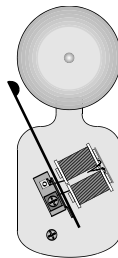

800-5702 BR-2 BELL RINGER W/O BELL

# GRADE CROSSING ANIMATORS

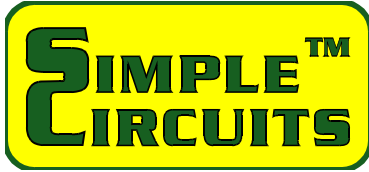

SIMPLE CIRCUITS™ ARE IDEAL FOR MODELERS INTERESTED IN LAYOUT ANIMATION WITH A MINIMUM INVESTMENT OF TIME AND MONEY. EASIER CONNECTIONS, LESS COSTLY, YET STILL MULTI-FEATURED, CIRCUITRON PRODUCTS WITH THE SIMPLE CIRCUIT™ DESIGNATION ARE PERFECT FOR ANIMATING GRADE CROSSINGS WHEN TRUE-PROTOTYPE ACTION IS NOT REQUIRED.

## GRADE CROSSING ANIMATORS



These low-cost circuits feature complete Train Detection, an Alternating Flasher and TORTOISE™ Gate Driver Circuitry on one circuit board. Different models for 2 rail DC track power or for 3 rail AC track power in all scales.

### GA-1 GRADE CROSSING ANIMATOR

Provided with 2 Opto-Sensors, the flasher outputs will be on when either is shaded. Drives LEDs or Lamps at up to 250 ma. per side. Also directly powers one TORTOISE™ (not included) for gate activation. The **GA-1** will not detect short trains falling between sensors. One additional sensor may be added (see Accessories) but this will reduce the overall sensitivity of the circuit. Adjustable for varying light intensity, but not for use in very low-light situations. 10-18 volt AC or DC input. Add DT-5 (below) for additional track(s).



800-5260 GA-1 GRADE CROSSING ANIMATOR

### DT-5 GRADE CROSSING DETECTOR



Same detection as the **GA-1** but without the alternating flasher and gate driver. Use with the **GA-1** for multiple track crossings. May also be used with other Circuitron flashers such as the **FL-2** and **FL-3** (see Pages 20-21) . Adjustable for varying light intensity but not for use in extremely low-light situations. 10-18 volt AC or DC input.

800-5205 DT-5 GRADE CROSSING DETECTOR

### GL-1 GRADE CROSSING ANIMATOR

CIRCUITRON's **GL-1** has the same features as the **GA-1** but has been designed specifically for 3 rail AC track power where an isolated section of outside rail is used for detection. No Opto-Sensors are necessary. No light limitations. No Detection Circuit needed for additional tracks.



800-5261 GL-1 3-RAIL GRADE CROSSING ANIMATOR

FOR A WIDER RANGE OF FEATURES AND GREATER SENSITIVITY, CHOOSE ONE OF CIRCUITRON'S FULL FEATURED DETECTION OR DETECTOR/FLASHER CIRCUITS.  
 SEE PAGES 17 - 21

# UNIVERSAL TRAIN DETECTORS

Universal Train Detectors are "Building Block" circuits featuring single point detection. They are designed to provide panel indications from lamps or LEDs whenever a train is at one specific point and they may serve as the initiating detection for various animation and train control functions. They provide an output connection to Ground [-] which is universally adaptable to computer controls. **CIRCUITRON** products commonly used with Universal Train Detectors include our Time Delay Circuit, External Relays and Turnout Control Circuits.

## DT-4 ROLLING STOCK DETECTOR

The **CIRCUITRON DT-4** provides the modeler with an ideal system for spotting a train or even a single piece of rolling stock in a hidden location.

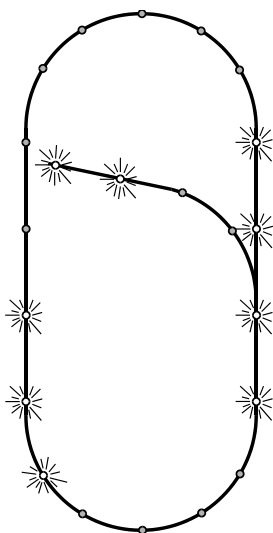

The **DT-4** actually contains four completely independent detection circuits combined onto one circuit board. Each of the separate sections may be used alone or in conjunction with each other at various points on a layout. The **DT-4** utilizes our proven Opto-Electronic principle (see **DETECTION SYSTEMS - AN OVERVIEW**) and provides a signal at one of the

output terminals whenever the corresponding Opto-Sensor is shaded from the ambient room light by a piece of rolling stock. Independent sensitivity controls are provided to adjust each of the 4 circuits to varying lighting conditions. The **DT-4** can be used for *any* scale and will detect all powered and unpowered rolling stock with *no modifications necessary*. Each output on the **DT-4** provides a connection to 'negative' (ground) when the Opto-Sensor is covered and the output is ON. Like all **CIRCUITRON** Detection circuits, these outputs will each control up to 250 ma. of DC accessories or lamps. The **DT-4** is constructed on a 3" x 3" printed circuit board and requires a 6 - 20 volt DC power source. For greatest

stability and ease of adjustment, the power supply should be filtered or regulated (see section on **POWER SUPPLIES**).

One of the most useful applications for the **CIRCUITRON DT-4** is to light panel lamps for spotting rolling stock in a hidden location. If the Opto-Sensors are installed at set intervals along the track, a train's progress can be easily monitored on the control panel, even when it is completely hidden from view. In similar fashion, one of the **DT-4**'s Opto-Sensors can be located near the end of a blind siding. The output can be used to light a panel light, sound a warning buzzer, or activate a relay which will cut power to the track. Many modelers have found the **DT-4** indispensable when used in hidden staging yards. An Opto-Sensor placed at the end of each track, and another just beyond each fouling point gives clear visual indications of where trains are located and whether any are fouling the turnouts.

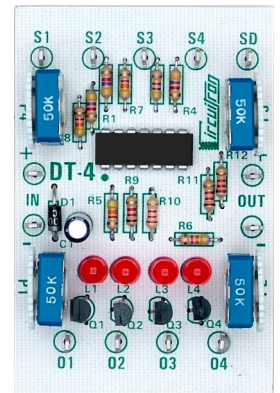

Finally, the **DT-4** is the ideal circuit to activate a multitude of **CIRCUITRON** train control circuits such as the Time Delay circuit, Turnout Controls, External Relays and the delay section of the **AR-2** Automatic Reverse Circuit.

800-5204 DT-4 ROLLING STOCK DETECTOR

## DT-6 INFRARED DETECTION CIRCUIT - REFLECTIVE

[RESERVED FOR FUTURE PRODUCT UNDER DEVELOPMENT]



# BLOCK SIGNALING CIRCUITS

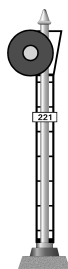

Prototype railroads break their mainlines into blocks in order to allow multiple trains to run safely on the same track. Block signals of many different designs inform the train crew what the status of the oncoming blocks are, and whether they may be occupied by another train. Model railroad layouts rarely have a real

*need* for prototype signaling systems, but the addition of these components adds a tremendous amount of realism, and viewers are always impressed by the changing signal lights as the trains pass by.

**CIRCUITRON** manufactures a complete line of Block Occupancy Detection Circuits (both optical and current-sensing) and Signal Driver Circuits for most all common signaling applications. These circuits have been designed with simplicity and easy-hookup as the primary goals. All the Detection circuits are 'stand-alone' units that may be used to provide signaling in key locations on a layout, without forcing you to provide detection for the *entire* layout. However, these **CIRCUITRON** Detectors and Drivers *are* designed for easy daisy-chain wiring of multiple blocks, if desired, and they will all snap into sections of our **PCMT** (Printed Circuit Mounting Track) for simple installation. All **CIRCUITRON** Block Detection circuits can be used to directly control two color signals *without any additional drivers!* If you want three-color signals, a Signal Driver circuit must be used for each signal. A common 3-color installation for bi-directional traffic would require a Block Detection circuit for each block, two 3-color Signal Drivers and your choice of two (2) three-color block signals or semaphores, one for each end of the block. Turnout Interlocking of **CIRCUITRON's** Signal Driver circuits, Absolute-Permissive Block Control (APB) and Centralized Traffic Control (CTC) operation can all be implemented, if desired, but the details of these more complex hookups are not contained in the general **CIRCUITRON** instructions included with these circuits. Consult the factory for further information.

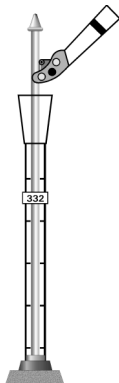

## BD-1, BD-1HD BLOCK OCCUPANCY DETECTOR - OPTO-ELECTRONIC

The **CIRCUITRON BD-1** is an advanced, integrated circuit design Block Occupancy Detector utilizing our proven Opto-Electronic design which provides positive indication whenever a block-section of a layout is occupied by any piece of rolling stock. Two pair of **CIRCUITRON** Opto-Sensors (included) are mounted between the ties at the end points of the block that is to be protected. Any piece of rolling stock entering the

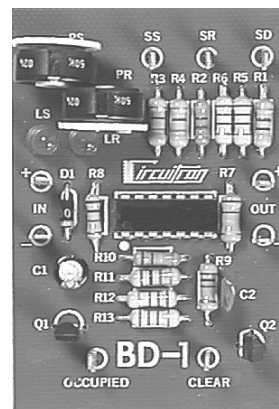

block shades the Opto-Sensors from ambient room light which activates the logic circuitry on the **BD-1** circuit board. No modifications to rolling stock are necessary. The **BD-1** is bi-directional and will give proper indications even if a train leaves a block by reversing direction and backing out. The **CIRCUITRON BD-1** also contains driver circuitry sufficient to power a pair of two-color LED (including 2 lead Bi-Color LEDs) or incandescent lamp block signals at each end of the protected block (LED-type signals must be wired with a common anode [+ ] configuration). The outputs on the **BD-1** can control a maximum of 250 ma. For 3-color signaling, additional signal drivers will be necessary (see our **SD-x** series of drivers later in this section). The **BD-1** requires a 10-18 volt DC input for proper operation. The power supply *should* be filtered for proper operation. If you do not have a filtered power supply, the **CIRCUITRON PS-1** filtered AC to DC Converter or **PS-2** Regulated AC to DC Converter are ideal for this application. The **BD-1** is constructed on a 2" x 3" printed circuit board.

The **BD-1HD** is identical to the **BD-1** but includes heavy duty output transistors to power lamps in large scale signals. Each output on the **BD-1HD** can control 500 ma.

- 800-5501 BD-1 BLOCK OCCUPANCY DETECTOR - OPTO-ELECTRONIC
- 800-5521 BD-1HD HEAVY DUTY BLOCK DETECTOR - OPTO-ELECTRONIC

# APPLICATIONS

On the following pages, you will find many examples of how **CIRCUITRON** products can be used to enhance the realism of your layout. These Application Notes, along with their attendant diagrams, are *not* intended to show the complete hookup. Instead, they are designed to stimulate your imagination, and to give you *basic* ideas on how to best utilize our products. Many circuit board terminals, wires and connections have not been shown, in order to keep the diagrams clear and concise. All the actual inter-connections between circuits and components will be clearly explained in the instructions packed with *every* **CIRCUITRON** product. If you would like additional information on the circuits used in a particular application, you may send us a SAE and request the instruction sheet(s). As time permits, we will be adding our instruction sheets to our web-site at [www.Circuitron.com](http://www.Circuitron.com).

Undoubtedly, your applications may vary to some extent with those that we have chosen to illustrate here. This is not a problem. Often times, there may be a number of approaches that will all yield satisfactory results. In all situations described on these pages, we have attempted to keep the number of circuits (and therefore the cost) to a minimum while still accomplishing our design requirements. However, in many cases, the use of a different **CIRCUITRON** device may work just as well, and in no way are we implying that there is only one way to accomplish a certain end result. In addition, there are countless other applications for **CIRCUITRON** products that are not shown here simply because we don't have the room.

Use your imagination! Experiment! Most importantly, have fun! With **CIRCUITRON** products, you don't need any real electronics knowledge. Our detailed instructions will take you step by step through the complete hookup, and when you are finished, you will be amazed at how simple the job was. Most importantly, *everyone* will be impressed by the amount of excitement and realism your new **CIRCUITRON** accessories have added to your layout.

## FINE PRINT

Although all of these applications are based on sound design principles, some of them are untested in actual layout situations. No guarantee or warranty is expressed or implied regarding suitability to task. Should you encounter a problem with any of these applications, or if you notice any errors that might have crept into our drawings, please inform us so that we may correct the problem and work with you on your particular application.

# 101

## SINGLE TRACK GRADE CROSSING

**APPLICATION:** To provide realistic, bi-directional grade crossing flashers for a road crossing a single track.

**REQUIRED:** (1) **DT-1** OR **DT-2** 800-5201 OR 800-5202  
(1) **FL-2** OR **FL-2HD** 800-5102 OR 800-5122  
YOUR CHOICE OF CROSSBUCK SIGNALS

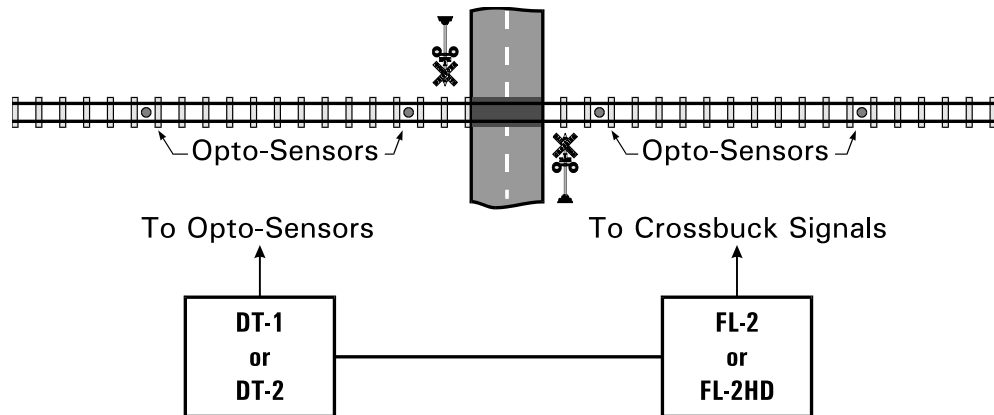

**NOTES:** You may use a **DT-3** in place of the **DT-1** or **DT-2** if your track has only single direction traffic.

# 102

## SINGLE TRACK, 3 GRADE CROSSINGS

**APPLICATION:** To provide realistic, bi-directional grade crossing flashers at 3 separate road crossings of one track.

**REQUIRED:** (3) **DT-1** OR **DT-2** 800-5201 OR 800-5202  
(1) **FL-3** 800-5103  
YOUR CHOICE OF CROSSBUCK SIGNALS

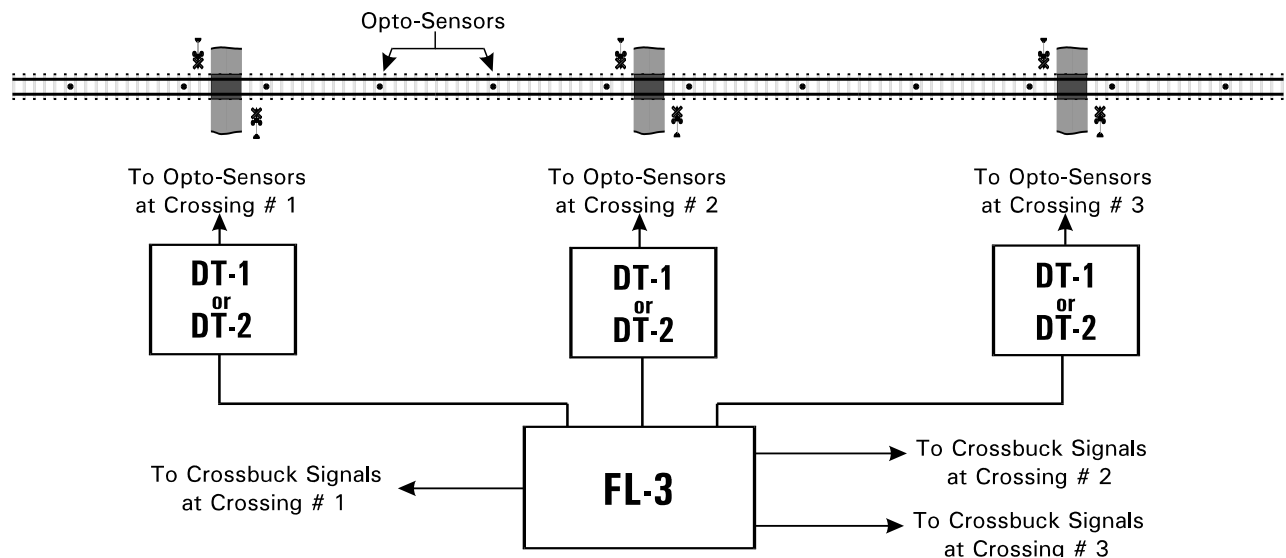

**NOTES:** It is not necessary that all the grade crossings be on one track. The **FL-3** will provide independent control of up to 3 crossings *anywhere* on your layout. If your trackage is single direction only, you may substitute a **DT-3** for the **DT-1** or **DT-2**.

# 103

## HIGH RAIL (LIONEL) GRADE CROSSING

**APPLICATION:** To provide realistic, bi-directional grade crossing flashers for a road crossing a single track with 3-Rail AC track power.

**REQUIRED:** (1) **FL-2HD** 800-5122  
YOUR CHOICE OF CROSSBUCK SIGNALS

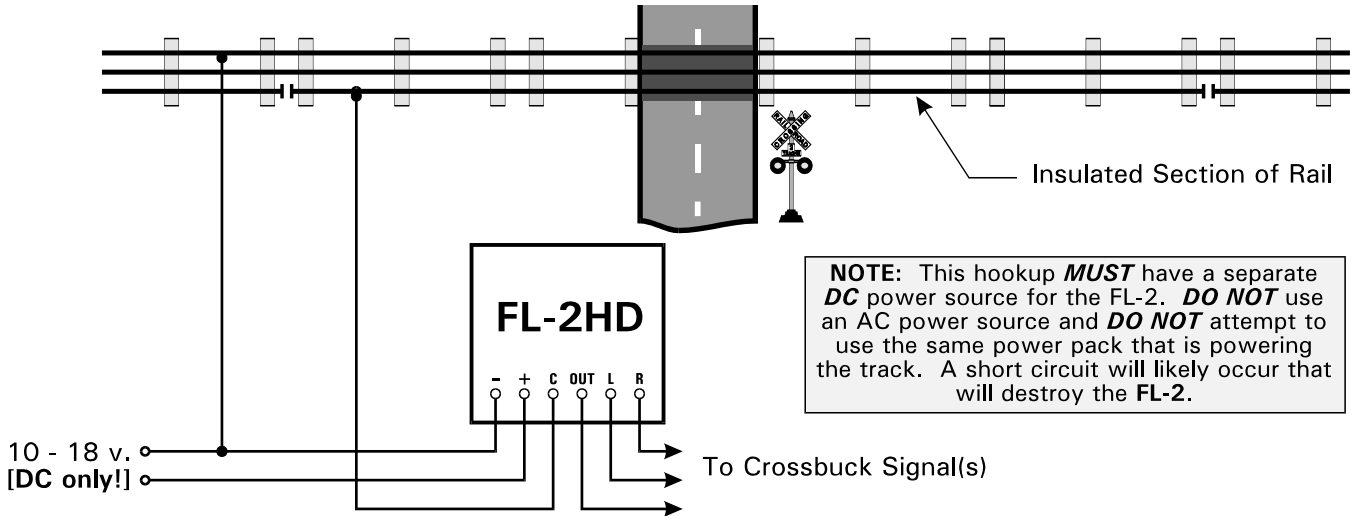

**NOTES:** No detection circuit is necessary as the isolated outside rail provides the ground [-] signal necessary to control the FL-2HD.

# 104

## MULTIPLE TRACK GRADE CROSSING - MAINLINE

**APPLICATION:** To provide realistic, bi-directional grade crossing flashers where a highway crosses 2 or more parallel mainline tracks.

**REQUIRED:** (1) **DT-1** OR **DT-2** FOR EACH TRACK 800-5201 OR 800-5202  
(1) **FL-2** OR **FL-2HD**  
YOUR CHOICE OF CROSSBUCK SIGNALS

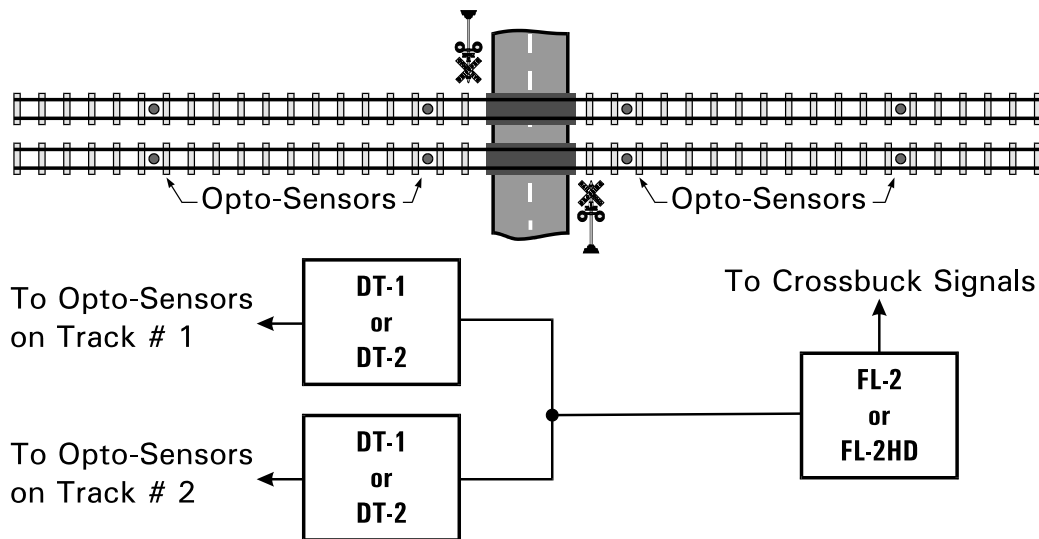

**NOTES:** Other Detection Circuits for additional tracks may be added in similar fashion. Only one FL-2 or FL-2HD is needed for any number of tracks. If your trackage is single direction only, you may substitute DT-3s for the DT-1s or DT-2s.

## 105 MULTIPLE TRACK GRADE CROSSING - SIDINGS

**APPLICATION:** To provide realistic, bi-directional grade crossing detection for 2 parallel tracks when one is a siding off of the other.

**REQUIRED:** (1) PACKAGE OF OPTO-SENSORS 800-9201, 9202 OR 9206 AS NEEDED

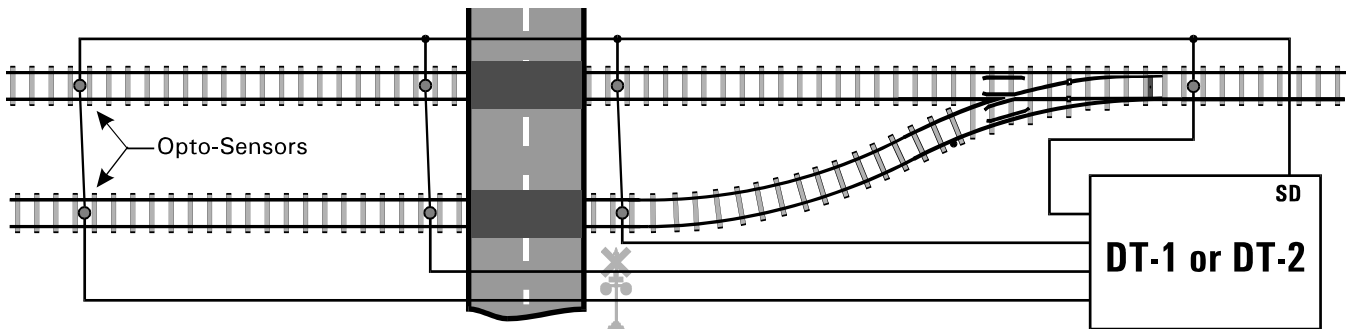

**NOTES:** Additional Opto-Sensors are easily added by wiring in series with the originals. This application is only suitable for sidings and spurs where track power is derived from the mainline and is *always* the same polarity as the mainline. Series connection of additional Opto-Sensors can be done with *any* **CIRCUITRON** Detection Circuit.

## 106 CROSSING GATES USING THE TORTOISE™

**APPLICATION:** The **CIRCUITRON TORTOISE™** may be easily connected to the output of any **CIRCUITRON** Detection Circuit for driving crossing gates.

**REQUIRED:** (1) **TORTOISE SWITCH MACHINE** 800-6000  
 (1) **ER-2 (OR ANY SMALL DPDT RELAY)** 800-5624  
 (1) **ANY CIRCUITRON DETECTION CIRCUIT**

NOTE: If using the ER-2, connect as shown and disregard all connections within the dotted lines. If the TORTOISE runs in the wrong direction, interchange connections to 3 and 4.

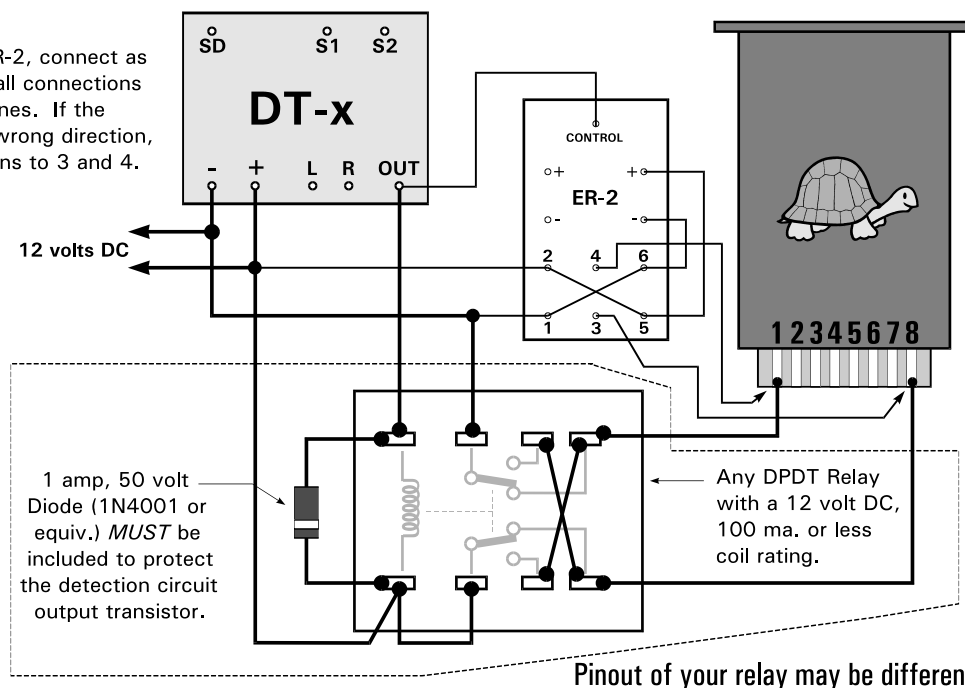

**NOTES:** Although the diagram shows the connections for a bare DPDT relay, a **CIRCUITRON ER-2** can be used for the simplest wiring. The diode shown is already included on the **ER-2**. The mechanical linkage and mounting are left up to the modeler.

## 110 ROLLING STOCK DETECTOR

**APPLICATION:** To provide a means of detecting a train when it is completely hidden from view. The system will detect *every* piece of rolling stock without modification and will operate with *all* forms of track power.

**REQUIRED:** **DT-4** 800-5204  
YOUR CHOICE OF PANEL LAMPS OR LED INDICATORS

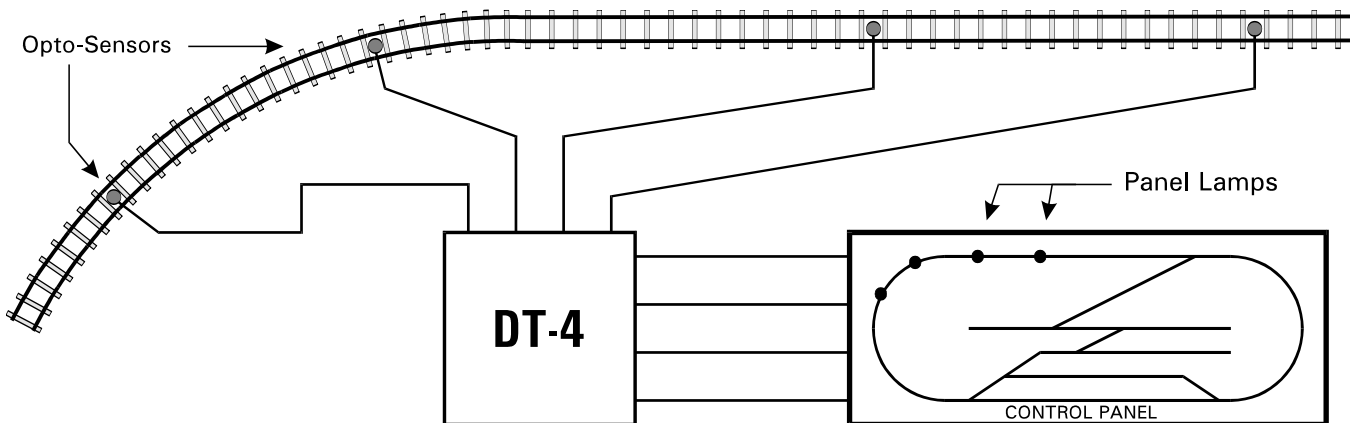

**NOTES:** As many **DT-4** circuits as necessary may be used to provide indications wherever desired on a layout. As well as lighting panel lamps, the **DT-4** outputs may be used to activate Turnout Controls, Relays and other accessories.

## 115 MANUAL OVERRIDE OF OPTICAL DETECTORS

**APPLICATION:** To provide manual override switches to be used along with the Opto-Sensors supplied with any **CIRCUITRON** Opto-Electronic Detection Circuit or Automatic Reverse Circuit.

**REQUIRED:** YOUR CHOICE OF PANEL PUSHBUTTONS OR TOGGLE SWITCHES

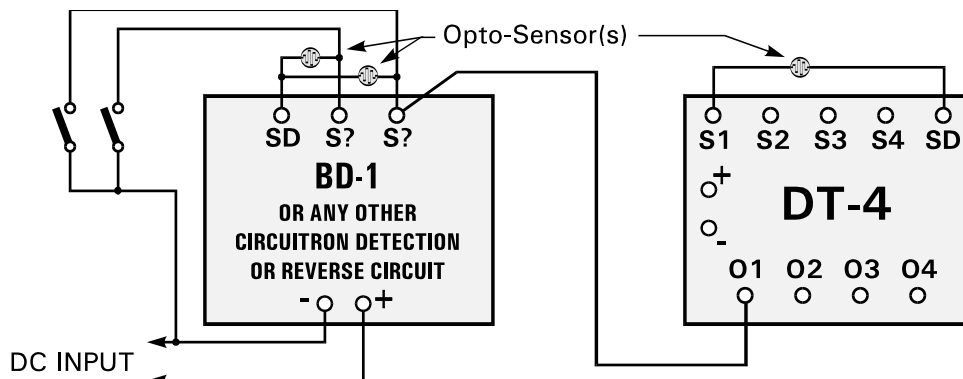

**NOTES:** Useful for adding turnout interlocking controls with the **BD-1** Block Detector and to provide manual reversing capability with the **AR-1** or **AR-2**. The output of a **DT-4** can also be wired as shown to activate a different Detection Circuit such as the **BD-1**. Doing so allows virtually any number of **DT-4** outputs to control one input such as when a number of sidings are present and you wish to detect a train entering or leaving a block via any one of them.

**APPLICATION:** To provide operating 2 color Block Signals for bi-directional train traffic. The system will provide positive "Occupied" indications whenever any piece of rolling stock is within the block and a "Clear" indication when no train is detected. The system will be able to power 2 color signals at each end of the block without additional drivers.

**REQUIRED:** (1) **BD-1** OR **BD-1HD** (FOR EACH BLOCK ) 800-5501 OR 800-5521  
YOUR CHOICE OF BLOCK SIGNALS (MAY BE LAMP OR LED TYPE)

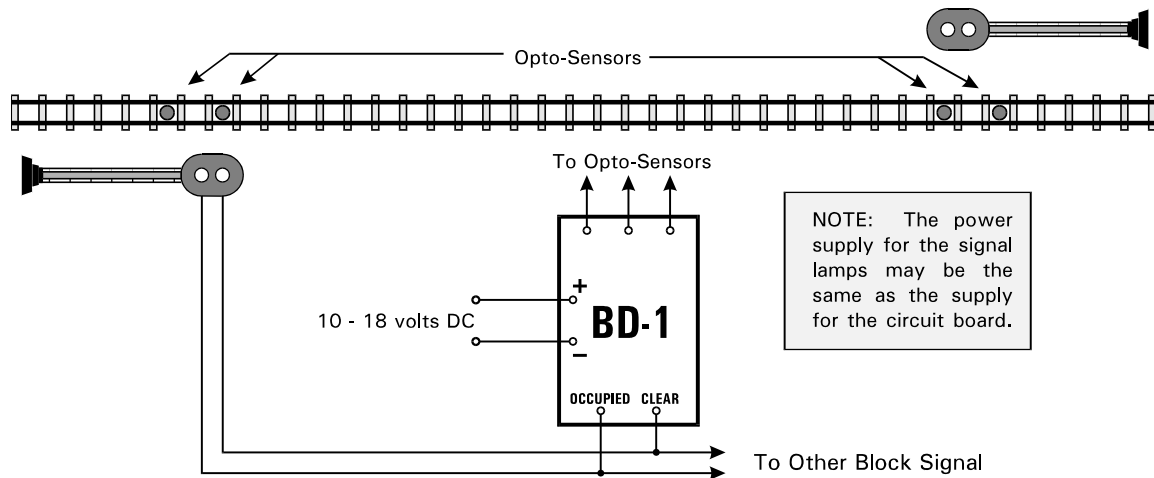

**NOTES:** The **CIRCUITRON BD-2** or **BD-2HD** may be used in place of the **BD-1**. Opto-Sensors are not used with the **BD-2** and **BD-2HD**.

**APPLICATION:** Two color Block Signals are easily controlled on 3-Rail AC track power layouts without using Detection Circuits or mechanical contactors.

**REQUIRED:** (1) **ER-1** (PER BLOCK TO BE SIGNALLED) 800-5602

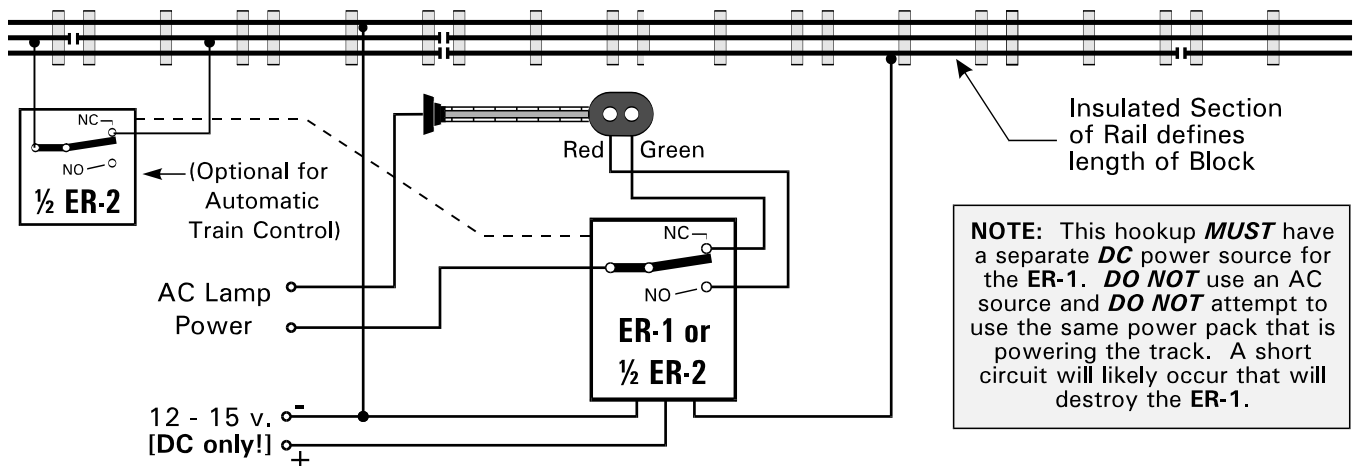

**NOTES:** This system is most easily implemented when used with Gargraves or similar insulated tie track. Tinplate track will require the addition of fiber insulators under the rail. If you want to add automatic train control, use  $\frac{1}{2}$  of an **ER-2** in place of the **ER-1** and use the other half to control center rail power as shown above.

# 210

# BLOCK SIGNALS WITH AUTOMATIC TRAIN CONTROL

**APPLICATION:** To provide operating 2 color Block Signals with automatic train control that will stop a train before an occupied block (Single Direction Traffic Only).

**REQUIRED:** (1) **BD-1** OR **BD-2** (PER BLOCK) 800-5501 OR 800-5502  
 (1) **ER-1** (PER BLOCK) 800-5604  
 YOUR CHOICE OF BLOCK SIGNAL

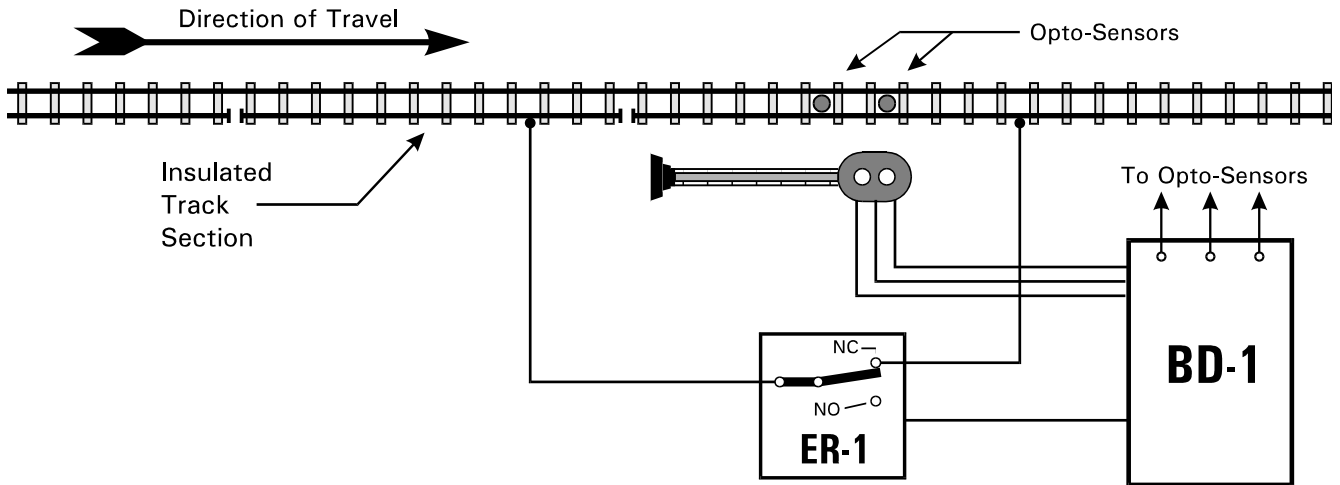

**NOTES:** The Block Detector is connected as in Application 201. Although the detection circuit will still give bi-directional indications, Automatic Train Control requires that train traffic always proceeds in the same direction. A cutout switch can be wired between the **BD-1** and the **ER-1** to disable the Automatic Train Control, if desired.

# 215

# 3 COLOR BLOCK SIGNALS

**APPLICATION:** To provide operating 3-Color block signals which will automatically display all 3 aspects (red, amber and green).

**REQUIRED:** (1) **BD-1** OR **BD-2** PER BLOCK 800-5501 OR 800-5502  
 (1) **SD-1, SD-2** OR **SD-3** PER SIGNAL 800-5510, 5520 OR 5530  
 YOUR CHOICE OF BLOCK SIGNALS OR SEMAPHORES

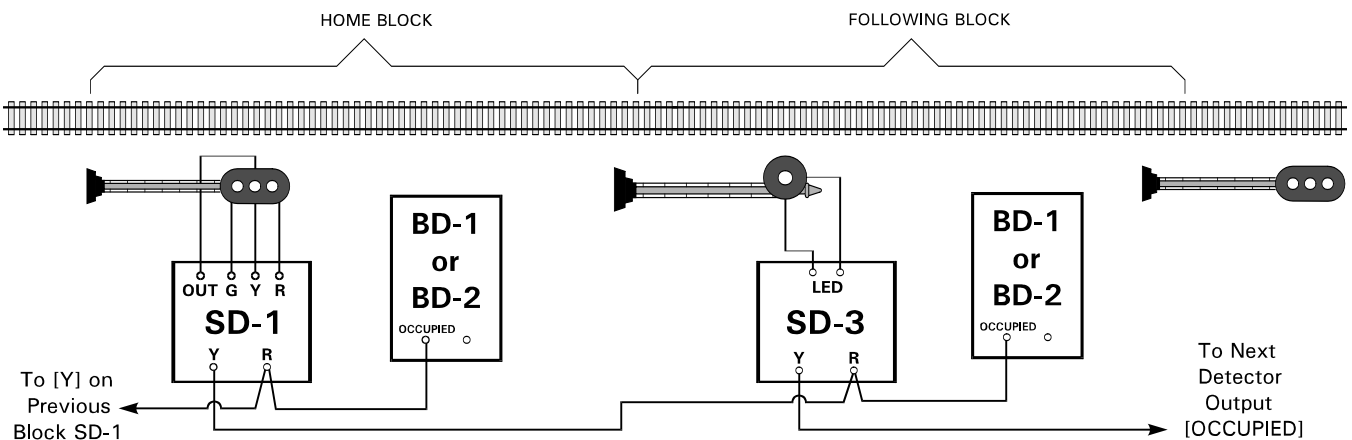

**NOTES:** Bi-directional applications require 2 signals and 2 Signal Drivers per block.



## 301 AUTOMATIC REVERSING - POINT TO POINT

**APPLICATION:** To provide automatic reversing of train direction on a point to point layout.

**REQUIRED:** (1) **AR-1** OR **AR-2** 800-5400 OR 800-5401

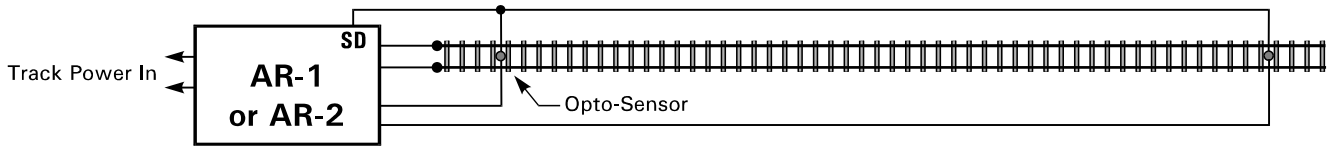

## 302 AUTOMATIC REVERSING - POINT TO POINT WITH SIDING

**APPLICATION:** To provide automatic reversing of train direction on a point to point layout that has one or more spur tracks. The train will reverse direction upon reaching the end of *any* of the spurs.

**REQUIRED:** (1) **AR-1** OR **AR-2** 800-5400 OR 800-5401  
 (1) **OS-1** 800-9201

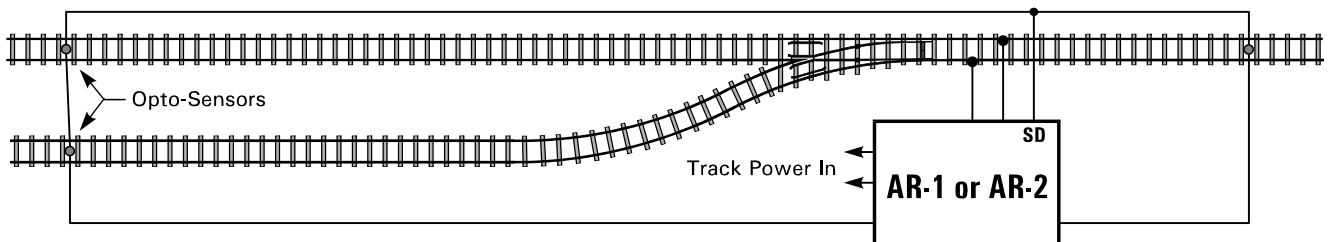

**NOTES:** Additional spur tracks can have reversing capability extended to them by purchasing additional Opto-Sensors and connecting them in series with the existing ones. A maximum of 3 Opto-Sensors can be connected on each side of the **AR-1** or **AR-2**. SEE APPLICATION 367 FOR AUTOMATIC TURNOUT SWITCHING.

## 303 AUTOMATIC REVERSING WITH DELAY AND INTERMEDIATE STOPS

**APPLICATION:** To provide automatic reversing of train direction on a point to point layout with delay times at each end. In addition, the train will stop at one or more intermediate points, delay, and then proceed on in the same direction without reversing.

**REQUIRED:** (1) **AR-2** 800-5401  
 (1) **DT-4** 800-5204

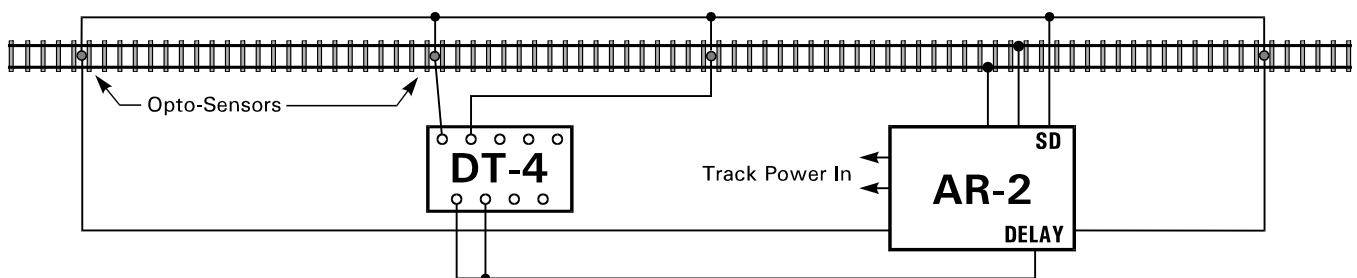

**NOTES:** Any number of intermediate stopping points can be established using additional **DT-4** outputs. The train length *must be less* than the distance between two Opto-Sensors or the automatic delay feature will not be activated.

**APPLICATION:** To provide automatic polarity switching on layouts that incorporate reverse loops.

**REQUIRED:** (1) **AR-1** OR **AR-1CC** 800-5400 OR 800-5410

### A) CONVENTIONAL WIRING - DOUBLE REVERSE LOOP

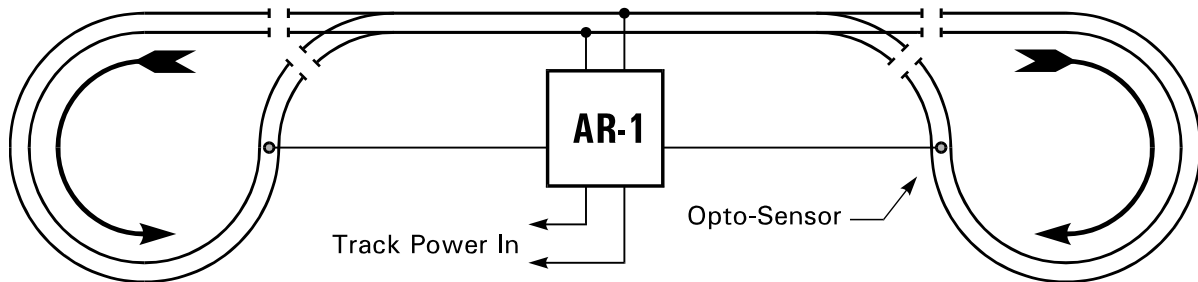

**NOTES:** The power pack is connected directly to the two loops, and the **AR-1** switches the polarity of the connecting mainline section. The arrows show the direction of travel through the loops. Entrance into the loops must always be from the same direction, although the initial wiring could be set up to be the opposite of that shown above. Automatic control of the turnouts can be achieved with a **DT-4** and (2) **TC-1** or **TC-3** Turnout Controls depending on whether you are using twin-coils or the **TORTOISE™**.

### B) Conventional Wiring - Single Loop

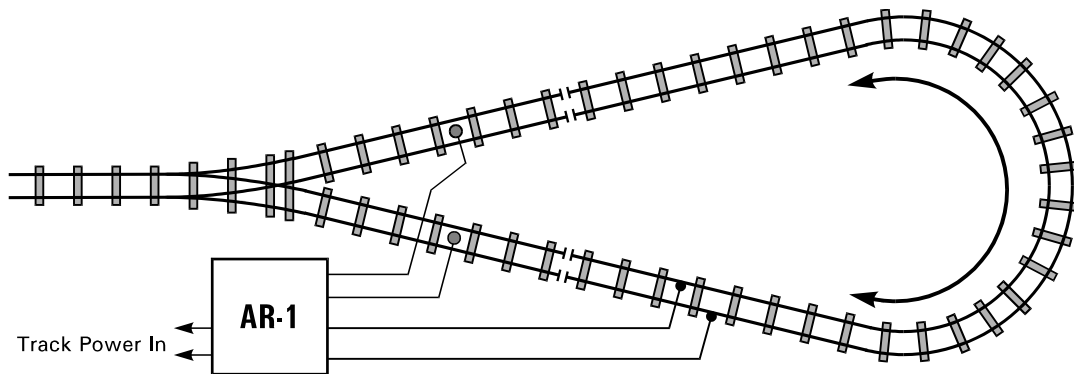

**NOTES:** This application of the **AR-1** allows entry into the loop from either direction. One **AR-1** is required for each loop. This application may be combined with the diagram above to control the mainline polarity when the train exits the loop.

### C) Command Control - Single Loop

It is unnecessary to switch the mainline polarity in Command Control Applications.

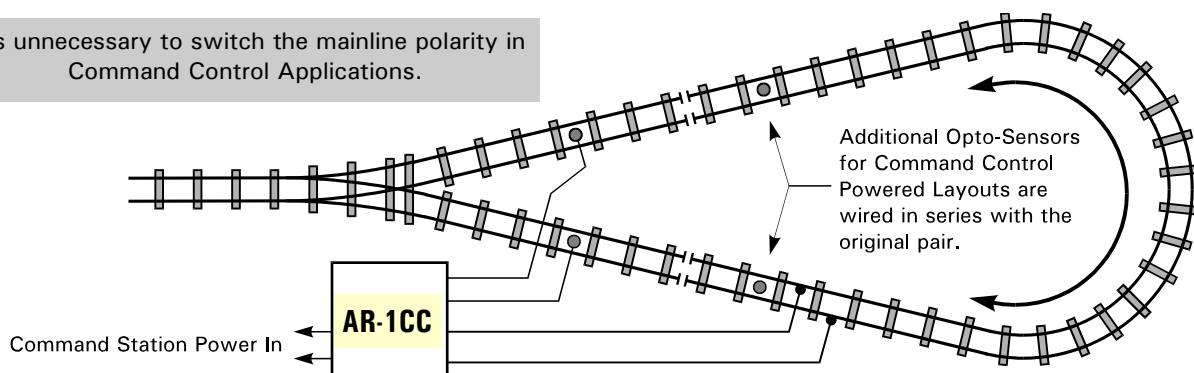

# 340

# NON-DERAILING TURNOUT CONTROL

**APPLICATION:** To provide automatic activation of switch machines by approaching trains in order to properly align the points so that derailments are prevented.

- REQUIRED:**
- |     |                     |                      |
|-----|---------------------|----------------------|
| (1) | <b>DT-4</b>         | 800-5204             |
| (1) | <b>TC-1 OR TC-3</b> | 800-5605 OR 800-5615 |

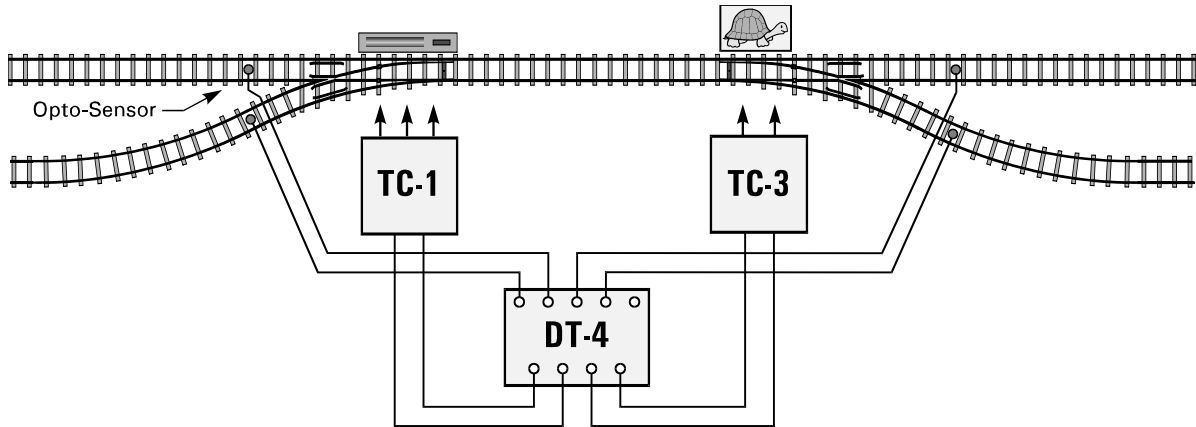

**NOTES:** Manual pushbuttons will need to be added to allow control of the **TC-1** or **TC-3** from the control panel. The instructions cover this simple procedure. The **TC-1** and **TC-3** Turnout Control Circuits can also be activated without the use of the **DT-4** when used with 3-Rail AC powered layouts. Refer to Application 103 for information about using an isolated section of one of the outside rails in order to provide the ground [-] control signal the Turnout Controls require.

# 352

# AUTOMATIC STOP & DELAY WITH SLOWDOWN

**APPLICATION:** To provide automatic train stopping at a station, factory, etc. The train will reduce speed before coming to a stop. After an adjustable time, the train will leave the stopping point at reduced speed, and after traveling a short distance, will return to the original speed.

- REQUIRED:**
- |     |             |          |
|-----|-------------|----------|
| (1) | <b>DT-4</b> | 800-5204 |
| (1) | <b>AS-1</b> | 800-5601 |
| (1) | <b>TD-1</b> | 800-5602 |

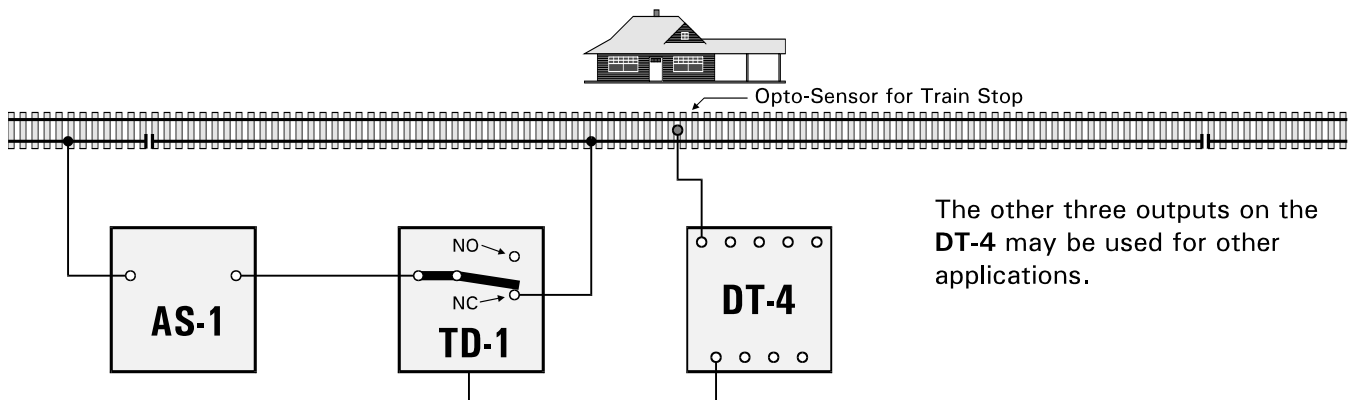

**NOTES:** If the slowdown feature is not needed, the **AS-1** may be eliminated. A lower cost, less flexible slowdown method is described under the **AS-1** listing in this catalog.

**APPLICATION:** To provide an automatic stop feature on a siding that is completely hidden from view. The system will work for all length trains (even if they are traveling forward or backward) and is useable with any type of track power.

- REQUIRED:**
- (1) **DT-4** 800-5204
  - (1) **ER-1** 800-5604
- YOUR CHOICE OF PANEL LAMPS OR LED INDICATORS

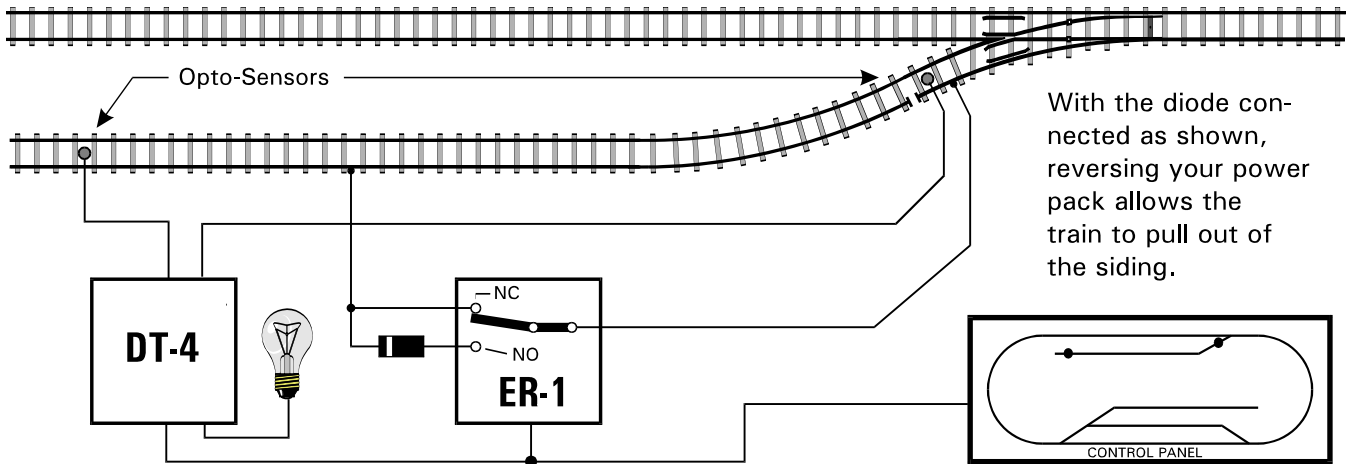

**NOTES:** The DT-4 pulls in the relay on the ER-1 when the first piece of rolling stock shades the Opto-Sensor at the end of the siding, removing power from the track. A panel lamp is lit to show siding occupancy. Another panel lamp (optional) may be added as shown using another section of the DT-4 to show that the turnout is not fouled.

**APPLICATION:** To provide all the automatic switching and reversing functions necessary in order to have completely unattended operation of a trolley, mine train or industrial switching setup.

- REQUIRED:**
- (1) **AR-1** OR **AR-2** 800-5400 OR 800-5401
  - (1) **DT-4** 800-5204
  - (2) **TC-2** OR **TC-4** 800-5606 OR 800-5616
  - (1) **OS-2** 800-9202

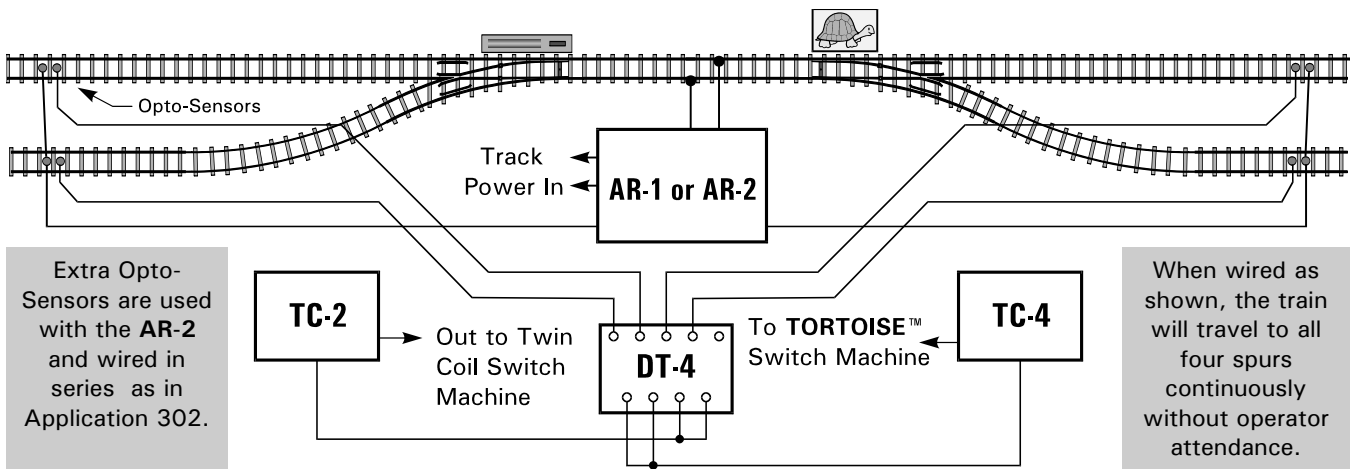

## 371 CROSSING CONTROL

**APPLICATION:** To provide automatic train control at a crossing in order to prevent collisions between trains on opposing tracks.

**REQUIRED:**

(1)	<b>DT-4</b>	800-5204
(2)	<b>ER-1</b>	800-5604
(2)	<b>OS-2</b>	800-9202

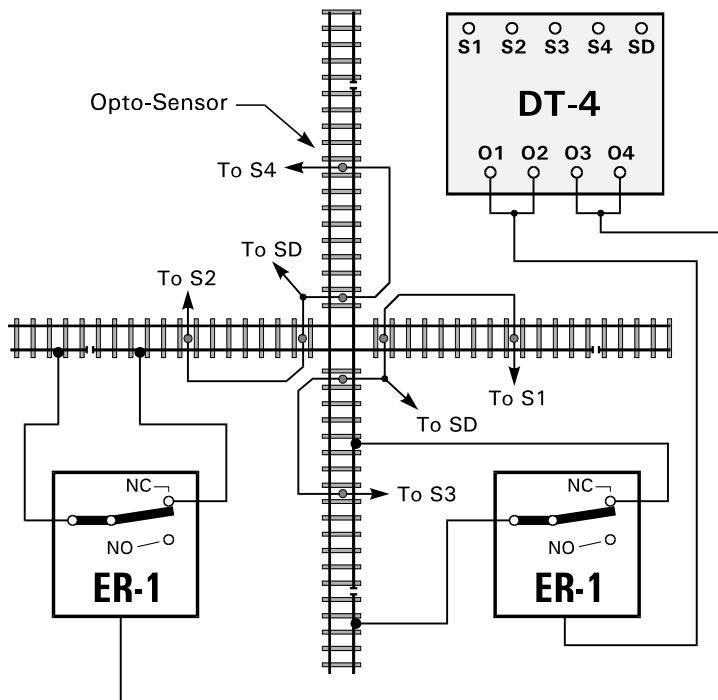

**NOTES:** Although this application may look complicated at first, it really isn't all that bad. We have shown more of the interconnections on this drawing than on many of our other applications. The extra Opto-Sensors are wired in series with the four that come with the DT-4. The extra sensors prevent the relays from releasing should a short train cross. If you run *very* short trains that might fall between Opto-Sensors, consider replacing the **DT-4** with (2) **BD-1s**, which would allow *any* length trains. The first train arriving at the crossover will activate the corresponding **ER-1** which will in turn cut the power to the other track. By making one track's isolated rail much longer than the other's, it will essentially eliminate a stall condition where trains arriving simultaneously cut power on *both* tracks.

## 385 ACCESSORY LAMP SEQUENCER

**APPLICATION:** To provide sequential illumination of lamp sets that may be used for changing room lights in homes, factories, etc. The 'ON' time of each set of lamps will be adjustable.

**REQUIRED:** (3) **TD-1** 800-5602

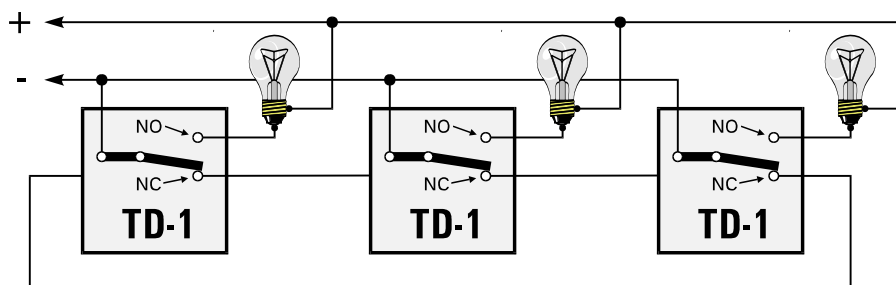

**NOTES:** The lamps may be powered off a different DC power supply than the one powering the **TD-1s** if both supplies have their [-] terminals connected together. Any number of lamps may be connected in parallel up to the 5 amp capacity of the **TD-1**.

## BLOCK SIGNALING CIRCUITS, CONT.

### BD-2, BD-2HD BLOCK OCCUPANCY DETECTOR - CURRENT SENSING

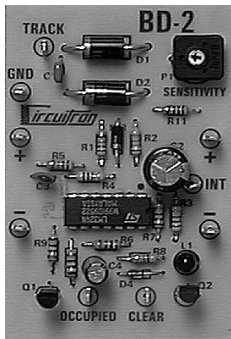

The **CIRCUITRON BD-2** is a very sensitive, integrated circuit design block detector which will work with virtually any scale and type of track power, including most forms of command control. The **BD-2** works by detecting the current drawn by a locomotive or lighted piece

of rolling stock. Detection can be extended to un-powered equipment by using metal wheelsets with resistors connected across the insulator (any value between 4700 and 10,000 ohms should work well). The **BD-2** senses

of 250 ma. The circuit boards are designed for easy daisy-chain wiring of multiple blocks and will snap into a section of our **PCMT** (Printed Circuit Mounting Track) for simple installation. The **BD-2** is constructed on a 2" x 3" printed circuit board and is available in standard 3 amp track power capacity (which is adequate for HO and smaller scales) and in a heavy duty 6 amp capacity version, the **BD-2HD**. Both circuits require a 10-18 v. DC power source for proper operation. The signal driving capacity of the **BD-2HD** is increased to 500 ma. per output and will work well with large scale equipment.

800-5502 BD-2 BLOCK OCCUPANCY  
DETECTOR - CURRENT SENSING

800-5522 BD-2HD BLOCK OCCUPANCY  
DETECTOR - HEAVY DUTY  
CURRENT SENSING

[SEE ACCESSORIES SECTION FOR EXTRA DIODES]



### DCC

ALTHOUGH THE BD-2 AND BD-2HD WERE DESIGNED FOR CONVENTIONAL AC OR DC TRACK POWER, THEY WILL WORK FINE WITH SMALLER DCC LAYOUTS THAT UTILIZE A SINGLE DCC TRACK POWER BOOSTER AND HAVE NO REVERSING LOOPS. FOR ALL OTHER DCC APPLICATIONS, WE RECOMMEND THE USE OF THE **BD-3** INSTEAD.

detection by "monitoring" the voltage drop across a pair of diodes. These diodes introduce a small voltage drop of 0.7 volts to the track. Although very slight, this voltage drop may be noticed when moving between blocks that have no detection and blocks protected by the **BD-2**. The simple solution is to install a pair of diodes wired in series with each of the un-detected blocks. An adjustment control is provided to set the sensitivity of the circuit and can be used to compensate for damp conditions, outdoor use, etc. At its most sensitive setting, the **BD-2** is capable of detecting 100,000 ohms or less across the rails. The **BD-2** also incorporates a turn-off delay of approximately 1/2 second to prevent loss of detection due to dirty wheels, etc. The **BD-2** will directly drive either LED-type or incandescent lamp, 2-color block signals and the outputs have a maximum current capacity

### BD-3, BD-3HD BLOCK OCCUPANCY DETECTOR - COMMAND CONTROL

The **CIRCUITRON BD-3** Command Control Block Occupancy Detector has been designed specifically for DCC powered layouts in any scale. It cannot be used with conventional track power, however, it will function properly with some other forms of Command Control such as Railcommand™, CTC-80 and CTC-16e. All of the **BD-3's** power supply and control electronics are completely isolated from the track power. No changes in wiring or special optical isolation are necessary for layouts utilizing reversing loops or multiple Power Boosters/Command Stations. In addition, no modifications need to be made to blocks that



ALL **CIRCUITRON** BLOCK  
OCCUPANCY DETECTORS HAVE  
'OPEN COLLECTOR' OUTPUTS.

THIS MEANS THAT WHEN THE OUTPUT TURNS 'ON', IT MAKES A CONNECTION TO THE NEGATIVE SIDE (- OR GROUND) OF THE POWER SUPPLY. WHEN THE OUTPUT IS 'OFF', IT IS AN OPEN CIRCUIT AND IT IS NOT CONNECTED TO ANYTHING. THIS CONFIGURATION MAKES **CIRCUITRON** DETECTORS UNIVERSALLY COMPATIBLE WITH ALL COMPUTER CONTROLS AND MOST OF THE FULL-FEATURED SIGNALING LOGIC CIRCUITS MADE BY OTHER MANUFACTURERS (ATARIS ENGINEERING, C/MRI, LOGIC RAIL TECHNOLOGIES, TRAC-TRONICS, ETC.)

## BLOCK SIGNALING CIRCUITS, CONT.

do not have detection installed. The **BD-3** will detect as little as 50,000 ohms across the rails and includes a sensitivity adjustment to set the response of the circuit to varying layout conditions. Like other **CIRCUITRON** Block Occupancy Detectors, the **BD-3** will directly drive either LED-type (common anode, which means positive [+] sides of LEDs are connected together to the signal common wire) or incandescent lamp, 2-color block signals and the outputs have a maximum current capacity of 250 ma. each. The **BD-3** is also compatible with Bruce Chubb's C/MRI Computer Model Railroad Interface System and solder pads are provided at the bottom of the circuit board to allow installation of a Molex™ connector which will make the **BD-3** Plug-Compatible with the C/MRI Detector Motherboard. The **BD-3** is constructed on a 2" x 3" Printed Circuit Board and requires a 10-18 volt DC input. The **BD-3HD** is identical to the **BD-3** but includes heavy duty 500 ma. outputs to control large scale signals with heavier current draw lamps.

- 800-5503 BD-3 BLOCK OCCUPANCY  
DETECTOR - COMMAND CONTROL
- 800-5523 BD-3HD BLOCK OCCUPANCY  
DETECTOR - HEAVY DUTY -  
COMMAND CONTROL

## SIGNAL DRIVER CIRCUITS

Although **CIRCUITRON** Block Occupancy Detectors can directly control 2-color block signals without any additional logic or drivers necessary, whenever you want to connect prototypical 3-color signals, you must have a driver circuit for each signal which will accept the outputs from the "home" and "following" block detectors and translate this information to drive the signal to the proper aspect. **CIRCUITRON** has driver circuits available for nearly all popular signal types including single and dual head searchlight with Bi-color or Tri-color Light Emitting Diodes, color light signals of any configuration (type D, type G, etc.), position light signals (Pennsylvania, Norfolk & Western, etc.) and color position light signals (B & O). We also have a semaphore driver to be used in conjunction with the **CIRCUITRON** TORTOISE™ Slow Motion Switch Machine.

### SD-1 SIGNAL DRIVER, 3 ASPECT, 3 LAMP / LED

The **CIRCUITRON SD-1** provides all the logic and output drivers to control any 3 lamp, 3 color Block Signal or multiple lamp Position Light Signal. The three outputs on the **SD-1** can each control a maximum of 250 ma. and they will power either LED or incandescent lamp type signals. If your signals use LEDs, make certain that they are connected with a common positive (anode)

connection of all LEDs (the signal should have 4 wires, and the "common" connection should go to [+]. Most, *but not all*, signal manufacturers follow this design. Detection circuits (such as the **CIRCUITRON BD-1, BD-2** or **BD-3**) that provide a logic low (- or ground) output are needed for a minimum of 2 blocks to display all three aspects. The **SD-1** is constructed on a 2" x 3" printed circuit board and requires a 10 - 18 volt DC input for proper operation.

- 800-5510 SD-1 SIGNAL DRIVER,  
3 LAMP OR LED

### SD-2 THREE POSITION SEMAPHORE DRIVER

The **SD-2** Semaphore Driver is designed for use with the **CIRCUITRON TORTOISE™** and an upper or lower quadrant semaphore style signal. *NOTE: Neither the TORTOISE™, the signal nor the signal linkage are included. See CIRCUITRON's Remote Signal Activator Kit on Page 35 .* The **SD-2** provides all the logic circuitry necessary to drive the signal to all three positions, and is designed to work with **CIRCUITRON BD-1, BD-2** or **BD-3** Block Occupancy detectors. Other detection circuits that provide a logic low (- or ground) output may also be used. A minimum of 2 blocks must have detectors installed to show 3 position indications. The **SD-2** measures 2" x 3" and requires a 10-18 volt DC power source for proper operation.

- 800-5520 SD-2 SEMAPHORE DRIVER

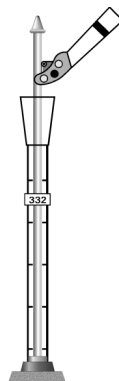
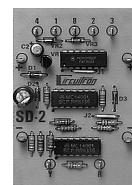
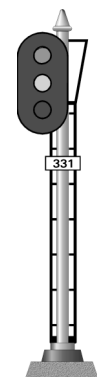
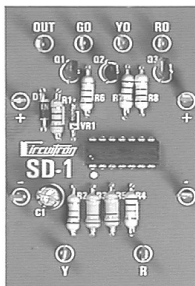

## SIGNAL DRIVER CIRCUITS, CONT.

### SD-3 SIGNAL DRIVER, 3 ASPECT, BI-COLOR LED

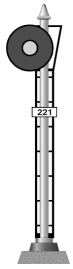

The CIRCUITRON **SD-3** is capable of driving any single searchlight style, 2 lead or 3 lead, Bi-Color or Tri-Color, LED-type signal to red, green and amber aspects. Compatible signals are manufactured by Oregon Rail Supply, Tomar, Sunrise Enterprises, ISS and others. Two **SD-3s** are required for double-head signals. NOTE: The **SD-3** will not drive 3 lamp signals (see **SD-1** above). Bi-color LEDs contain both a RED and a GREEN chip mounted side by side. Amber is achieved by alternately lighting the red and green LED chips at a high frequency. The eye perceives this mix of red and green as yellow (amber). A hue adjustment is provided on the **SD-3** to allow adjusting the amber color. The **SD-3** may be controlled by a single-pole, 3 position switch or automatically by detection circuits such as the **CIRCUITRON BD-1, BD-2** or **BD-3** (minimum of 2 blocks required). Other detection circuits that provide a logic low (ground or -) output may also be used. The **SD-3** is constructed on a 2" x 3" printed circuit board and requires a 10 - 18 volts AC or DC input (a DC power source is required when the **SD-3** is used with detection circuits).

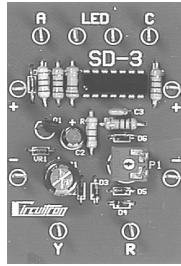

800-5530 SD-3 SIGNAL DRIVER,  
BI-COLOR LED

#### TECHNICAL TIP

CERTAIN BRANDS OF LEDs PRODUCE A MORE CONVINCING "AMBER" THAN OTHERS AND

THIS IS DUE TO THE TYPE OF LED CHIPS USED, THEIR LOCATION WITHIN THE PACKAGE AND THE AMOUNT OF DIFFUSION BUILT INTO THE EPOXY BODY. POOR LED DESIGN WILL YIELD DISTINCT RED AND GREEN ZONES AT THE FRONT OF THE LED RATHER THAN THE APPROPRIATE "AMBER" MIX. THIS IS NOT A DEFICIENCY IN THE **SD-3** CIRCUITRY.



# BLOCK & SEMAPHORE SIGNAL ANIMATORS

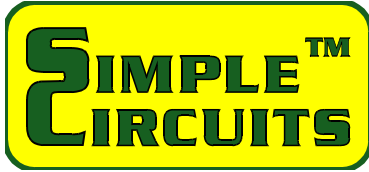

**SIMPLE CIRCUITS™** ARE IDEAL FOR MODELERS INTERESTED IN LAYOUT ANIMATION WITH A MINIMUM INVESTMENT OF TIME AND MONEY. EASIER CONNECTIONS, LESS COSTLY, YET STILL MULTI-FEATURED, **CIRCUITRON** PRODUCTS WITH THE SIMPLE CIRCUIT™ DESIGNATION ARE PERFECT FOR ANIMATING BLOCK AND SEMAPHORE SIGNALS WHEN TRUE-PROTOTYPE ACTION IS NOT REQUIRED.

## SIGNAL ANIMATORS

**COMPLETE, SIMPLE, SINGLE DIRECTION DETECTION, WITH TIMED 3-COLOR SIGNAL ANIMATION. SIGNAL TURNS RED AS TRAIN PASSES. AFTER LAST CAR CLEARS SIGNAL, ADJUSTABLE TIME DELAY STARTS (0 - 30 SECONDS). AFTER THE TIME DELAY COMPLETES, THE SIGNAL TURNS YELLOW. AFTER ANOTHER ADJUSTABLE TIME DELAY, THE SIGNAL GOES BACK TO GREEN. FOR 2 RAIL DC OR 3 RAIL AC TRACK POWER (DIFFERENT MODELS!) IN ALL SCALES.**

### SA-1 BLOCK SIGNAL ANIMATOR

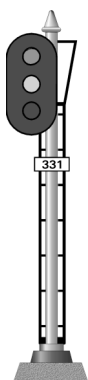

*For 3 Lamp (Red, Yellow and Green) or LED type signals and 2 rail DC track power.* DCC compatible. LED-type signals require common positive (anode) connection of all LEDs. Provided with 1 Opto-Sensor. Outputs (3) can control 250 ma. each. Adjustable for room light intensity but not for extremely low light situations. 10-18 volt AC or DC input.



800-5540 SA-1 BLOCK SIGNAL ANIMATOR

### SL-1 BLOCK SIGNAL ANIMATOR



*For 3 Rail AC Track Power.*

All other specifications are the same as **SA-1** above. Uses isolated section of outside rail for detection. No Opto-Sensors, no adjustments, no lighting limitations.

800-5541 SL-1 BLOCK SIGNAL ANIMATOR

### SA-2 SEMAPHORE ANIMATOR

For use with the **CIRCUITRON** Tortoise™ and an upper or lower quadrant semaphore signal. Linkage not included (see Remote Signal Activator on Page 35.) DCC compatible. Provided with 1 Opto-sensor. Adjustable for room light intensity but not for extremely low light situations. 10-18 volt AC or DC input.

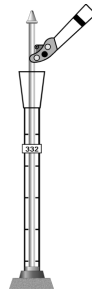

800-5544 SA-2 SEMAPHORE ANIMATOR

### SL-2 SEMAPHORE ANIMATOR



*For 3 Rail AC Track Power.*

All other specifications are the same as SA-2 above. Uses isolated section of outside rail for detection. No Opto-Sensors, no adjustments, no lighting limitations.

800-5545 SL-2 SEMAPHORE ANIMATOR

### SA-3 BLOCK SIGNAL ANIMATOR

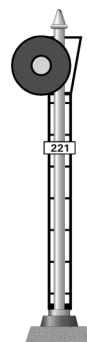

*For Bi or Tri-Color LED type target signals and 2 rail DC track power.*



DCC compatible. Amber hue fully adjustable. Provided with 1 Opto-Sensor. Output will drive one LED (2 or 3 lead OK) only. Adjustable for room light intensity but not for extremely low light situations. 10-18 volt AC or DC input.

800-5542 SA-3 BLOCK SIGNAL ANIMATOR

### SL-3 BLOCK SIGNAL ANIMATOR



*For 3 Rail AC Track Power.*

All other specifications are the same as SA-3 above. Uses isolated section of outside rail for detection. No Opto-Sensors, no adjustments, no lighting limitations.

800-5543 SL-3 BLOCK SIGNAL ANIMATOR

FOR A WIDER RANGE OF FEATURES AND GREATER SENSITIVITY, USE CIRCUITRON'S FULL FEATURED DETECTION & SIGNAL DRIVERS SEE PAGES 23-26

# TRAIN CONTROL CIRCUITS

## AUTOMATIC REVERSE CIRCUITS

**CIRCUITRON** manufactures a variety of Automatic Reverse Circuits that can be used for automatic point-to-point layout control and reverse loop applications. The new **AR-1CC** provides a very economical means to fully automate reverse loop polarity switching on Command Control layouts. All the Reverse Circuits utilize our proven Opto-Electronic detection with tiny Opto-Sensors mounted between the rails where they are shaded from ambient room light by a piece of rolling stock. No modifications to the equipment are necessary and the circuits will consistently reverse as soon as the first piece of rolling stock (powered or un-powered) passes over the sensor. It does not matter if the locomotive is at the beginning, in the middle or at the end of the train.

### AR-1 AUTOMATIC REVERSE CIRCUIT

The **CIRCUITRON AR-1** is a basic automatic polarity reverser that is ideally suited for use with point to point layouts, displays, test tracks or reverse loop setups. The **AR-1**

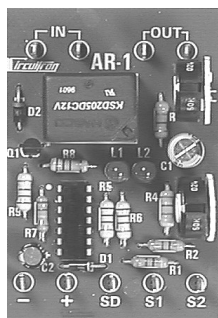

utilizes an integrated circuit design and can safely switch up to 5 amp loads, making it compatible with virtually all scales. The **AR-1** is constructed on a 2" x 3" printed circuit board and requires a *filtered* 12 - 15 volt DC supply for proper operation. See the catalog section on

**POWER SUPPLIES** for appropriate converters. The **AR-1** includes 2 Opto-Sensors which are adequate for most normal hookups (see **APPLICATIONS** section). Pushbuttons may be incorporated into the circuit for manual reversing, if desired.

800-5400 AR-1 AUTOMATIC REVERSE  
CIRCUIT

### AR-1CC REVERSE LOOP CONTROLLER- COMMAND CONTROL

The **AR-1CC** is identical to the standard **AR-1** except that it contains the 4 Opto-Sensors necessary to provide fully automated reverse loop polarity switching for command control layouts (see **APPLICATIONS** section).

800-5410 AR-1CC REVERSE LOOP  
CONTROLLER -  
COMMAND CONTROL

### AR-2 AUTOMATIC REVERSE CIRCUIT WITH ADJUSTABLE DELAY

The **CIRCUITRON AR-2** is a sophisticated, integrated circuit design, automatic polarity reverser for use on point to point layouts in any scale. The **AR-2**

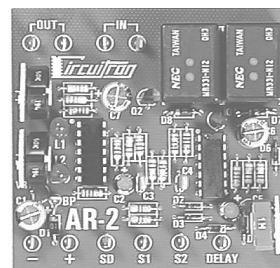

provides a 5 amp reversing capacity and also incorporates an adjustable time delay circuit that will stop a train at each reversing point for a set period of time

before reversing the direction. This time delay is adjustable from 0 to over 1 minute. In addition, a terminal is provided for external activation of the time delay circuitry *without* reversing direction. This terminal can be connected to a panel pushbutton or to the output of one of **CIRCUITRON's** detection circuits to permit stop and delays at any point. If a **DT-4** Rolling Stock Detector is used in conjunction with the **AR-2**, up to 4 intermediate stopping points can be established between the reversing points. This is ideal for trolley or switching setups where you would like to have a train shuttling between end points, making various stops along the way. The **AR-2** is constructed on a 3" square printed circuit board and requires a 12-18 volt AC or DC power supply for proper operation.

800-5401 AR-2 AUTOMATIC REVERSE  
CIRCUIT WITH  
ADJUSTABLE DELAY

**CAUTION:** See Power Supply Warning on Page 6

## TRAIN CONTROL CIRCUITS, CONT.

### AS-1 AUTOMATIC SLOWDOWN CIRCUIT

The **CIRCUITRON AS-1** Automatic Slowdown Circuit is a solid state circuit designed to provide a fixed step of train speed reduction within a section of track. This is very useful for automatic station stops or automatic downhill speed reduction. The **AS-1** offers distinct advantages over a dropping resistor for consistency of speed reduction independent of the load. When a resistor is used to drop

voltage, the voltage drop will vary depending on the load. If the resistor is chosen to provide the proper speed reduction with a locomotive drawing 0.5 amps, for example, this same resistor may stop a different locomotive entirely if its current draw is 1.0 amp. The solid state circuitry on the **AS-1** greatly reduces this problem, and one adjustment of the on-board output trimmer control will generally suffice for all loads. The **AS-1** is bi-directional and simply connects in series with one of the track leads. Heat sinking is sufficient for controlling up to 2 amp loads and the **AS-1** may be used with AC or DC track power (*Do not use with Command Control*). The output of the **AS-1** is continuously variable from 0 up to within 3 volts less than the input voltage. The circuit board measures 2" x 3". Note: The **AS-1** does not incorporate any momentum or gradual slowing effects. The speed reduction is a fixed step. Flywheels in most locomotives will reduce the abruptness of the change.

800-5601 AS-1 AUTOMATIC SLOWDOWN  
CIRCUIT

### TD-1 TIME DELAY CIRCUIT

The **CIRCUITRON TD-1** is designed to connect to the output of any **CIRCUITRON** Detection



Circuit (the **DT-4** is the usual choice) and will provide a variable delay period (adjustable from 0 to over 1 minute)

which can be used to control accessories, to provide automatic train stops, etc. The output of the **TD-1** is a single pole, double throw relay with 5 amp contacts. These contacts are adequate for controlling locomotives in *any* scale, and they can be used to either "make" a circuit connection for the time duration, or to "break" a circuit connection for the time duration. The **TD-1** requires

an 11-15 volt DC power source for proper operation. Although the power source does not need to be regulated, a filtered power source is preferred, and under no conditions should the input voltage exceed 15 volts. Since the accessory

terminals of most power packs have outputs in the 16-18 volt range (or more!), they are *not* a good choice for powering the **TD-1** (see **POWER SUPPLIES** section). The Trigger Terminals on the **TD-1** require a momentary or continuous connection to ground [-] to initiate the timing sequence. This connection can be supplied by most **CIRCUITRON** Detection Circuit outputs, reed switches, track contacts, pushbuttons, etc. Once the timing sequence has been started, further inputs to the Trigger Terminals will be ignored. The **TD-1** is constructed on a 2" x 3" printed circuit board.

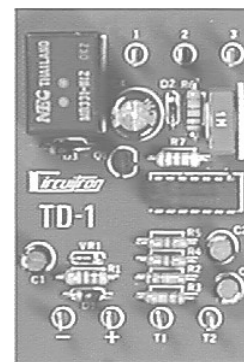

800-5602 TD-1 TIME DELAY CIRCUIT

#### TECHNICAL TIP

IF THE AMOUNT OF VOLTAGE REDUCTION YOU DESIRE IS LESS THAN THE APPROXIMATE 3 VOLT MINIMUM OF THE **AS-1**, CONSIDER USING A SIMPLE CHAIN OF 3 AMP DIODES IN SERIES. EACH DIODE WILL DROP THE VOLTAGE BY 0.7 VOLTS. SERIES CONNECT AS MANY AS YOU NEED TO

ACHIEVE THE REQUIRED DROP. YOU WILL NEED 2 SERIES CHAINS CONNECTED IN REVERSE PARALLEL FOR BI-DIRECTIONAL CURRENT FLOW. YOU MAY USE A DIFFERENT NUMBERS OF DIODES IN EACH DIRECTION IF YOU WANT MORE SLOWING IN ONE DIRECTION THAN THE OTHER. AN EXAMPLE OF A 2.1 VOLT DROP IN EACH DIRECTION IS SHOWN .



EXAMPLE: 2.1 VOLT DROP IN BOTH DIRECTIONS

## TRAIN CONTROL CIRCUITS, CONT.

### ER-1, ER-2 EXTERNAL RELAY CIRCUITS

Although the outputs on **CIRCUITRON** Detection Circuits are extremely flexible, they cannot directly control large amounts of current, or AC powered devices. With the addition of an external relay, though, these jobs are easily accomplished. It is possible to add a relay directly to the Detection Circuit output, but doing so requires that you wire a protection diode across the relay coil to protect the output transistor on the Detection board. Lower cost relays, such as the ones that Radio Shack sells are perfectly acceptable for this use, however, most of them are designed for printed circuit mounting, and you may find it difficult to make connections to them without mounting them on a circuit board.

The **CIRCUITRON ER-1** and **ER-2** are circuits consisting of a relay, either single pole / double throw (SPDT) in the case of the **ER-1**, or double pole / double throw (DPDT) in the case of the **ER-2**, and all of the necessary driver circuitry to enable them to be easily and directly connected to the output of any **CIRCUITRON** Detection Circuit. The relay contacts can be used to control AC or DC circuits and are ideal for use with all **CIRCUITRON** Block Occupancy Detectors to provide automatic train control. The

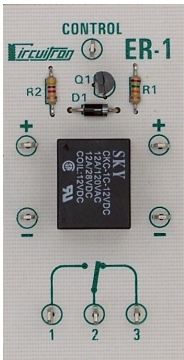

contacts on both of our External Relay Circuits are rated for a minimum switching capacity of 5 amps at either 12-24 volts DC or 110-115 volts AC.

#### CAUTION

*If you use these circuits to control high voltage such as the 110 volt line, be very certain you know what you are doing!*

Contact life should exceed 50,000 operations. Both the **ER-1** and the **ER-2** have 12 volt relays and require a supply voltage of 11 to 15 volts DC. The **ER-1** and **ER-2** present a negligible load on the Detection Circuit to which they are connected as the control current is only around 2 milliamps. The **ER-1** and **ER-2** are constructed on 1 1/2" x 3" printed circuit boards.

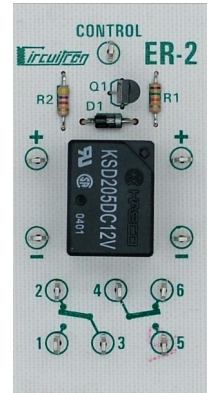

- 800-5604 ER-1 EXTERNAL RELAY - SPDT
- 800-5624 ER-2 EXTERNAL RELAY - DPDT

See the **ACCESSORIES** Section for a complete listing of Toggle Switches and other items useful for train control applications.

Automatic Turnout Controllers are listed in the **TURNOUT CONTROL** section.

# TURNOUT CONTROL

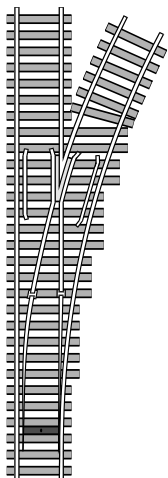

The **TORTOISE™** Slow Motion Switch Machine has practically revolutionized the way modelers feel about installing switch machines. With its prototypical slow motion, internal contacts and ultra-simple installation in all scales, it has quickly become the switch machine of choice for most new (and a great many retrofit) layouts. If you haven't tried one yet, you owe it to yourself to find out just how pain-free installing and powering a turnout (and switch machine) can be. Our **TC-3** and **TC-4** turnout control circuits are the perfect companions to the **TORTOISE™** whenever you want your switching action to be fully automated.

For those of you that have not yet given the **TORTOISE™** a try, and are still using twin-coil switch machines, **CIRCUITRON** hasn't forgotten you. Our **SNAPPER™** Twin Coil Switch Machine Power Supply and the **TC-1** and **TC-2** turnout controls will help to provide completely automatic operation while fully protecting your switch machine investment from burnout.

## ABOUT CAPACITOR DISCHARGE CIRCUITS

THE **CIRCUITRON SNAPPER™**, **TC-1** AND **TC-2** ALL CONTAIN CAPACITOR DISCHARGE CIRCUITRY. THESE CIRCUITS TAKE THE OUTPUT FROM A LOW-CURRENT SUPPLY AND USE IT TO CHARGE A STORAGE CAPACITOR. WHEN REQUIRED, THE POWER STORED IN THE CAPACITOR IS INSTANTLY DISCHARGED THROUGH THE SWITCH MACHINE COIL. THESE CIRCUITS WILL TAKE AN AC OR UNFILTERED DC INPUT AND CHARGE THE CAPACITOR TO THE *PEAK* VOLTAGE, RESULTING IN AN APPARENT *INCREASE* IN VOLTAGE OVER THE ORIGINAL. UNDERSTANDING THIS "PEAK-CHARGING" IS IMPORTANT TO ACHIEVING MAXIMUM SATISFACTION FROM THESE UNITS.

- 1) THE OUTPUT VOLTAGE OF THE CIRCUIT WILL BE APPROXIMATELY 1.4 TIMES THE MEASURED AC OR UNFILTERED DC INPUT.
- 2) A SMALL SPARE POWER PACK, FILAMENT OR BELL TRANSFORMER IS IDEAL FOR POWERING THESE CIRCUITS. HIGH CURRENT OR LARGE POWER PACKS OFFER NO ADVANTAGE, SINCE THE PEAK *VOLTAGE* WILL BE THE SAME REGARDLESS OF THE CURRENT.
- 3) THE AMOUNT OF POWER STORED IN THE CAPACITOR DEPENDS ON TWO THINGS, THE SIZE OF THE CAPACITOR AND THE INPUT VOLTAGE. POWER IS DIRECTLY RELATED TO THE CAPACITOR SIZE (DOUBLING THE CAPACITOR SIZE DOUBLES THE POWER), BUT IT IS DIRECTLY RELATED TO THE *SQUARE* OF THE VOLTAGE (DOUBLING THE VOLTAGE YIELDS *FOUR* TIMES THE POWER). AS YOU CAN SEE, A SMALL INCREASE IN VOLTAGE MAY MAKE A SIGNIFICANT DIFFERENCE IN TOTAL POWER STORED AND GOING FROM 16 TO 22 VOLTS ON THE INPUT WILL ALMOST DOUBLE THE OUTPUT POWER (AND THE NUMBER OF MACHINES THAT CAN BE ACTIVATED AT ONE TIME).
- 4) DO NOT USE A FILTERED OR REGULATED DC INPUT SINCE NO PEAK-CHARGING WILL OCCUR, AND LOSSES IN THE CIRCUITRY WILL RESULT IN AN OUTPUT *LOWER* THAN THE INPUT.
- 5) USE ONLY AS HIGH AN INPUT VOLTAGE AS IS NECESSARY TO POWER THE MAXIMUM NUMBER OF SWITCH MACHINES YOU ANTICIPATE THROWING AT ONCE. HIGHER VOLTAGES WILL ONLY RESULT IN GREATER WEAR AND TEAR ON YOUR SWITCH MACHINES WHEN YOU ARE THROWING THEM SINGLY.

## **SNAPPER™** TWIN COIL SWITCH MACHINE POWER SUPPLY



The **CIRCUITRON SNAPPER™** is an advanced design, solid state controlled switch machine power supply. Operating from the accessory terminals of a power pack or from any small AC transformer of 25 volts or less, the **SNAPPER™** provides positive, snap-action power to all twin-coil type switch machines while providing total protection from burnout due to stuck pushbuttons, short circuits, small children, etc.

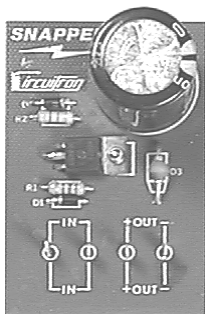

The **SNAPPER™** is a capacitor discharge circuit with a silicon controlled rectifier (SCR) controlled recharge. This design allows high power storage within the capacitor without sacrificing recharge time. The **SNAPPER™** helps to eliminate arcing at the control contacts, and will prevent lurching of a moving train when a switch machine is activated (if it is being powered by the same power pack). With a 24 volt AC input, the **SNAPPER™** should be able to activate between 4 and 10 switch machine coils (depending upon brand) if they are all connected to the same control. **Note:** Switch machines from different manufacturers will all have different coil current requirements, sometimes dramatically so. It may not be possible to intermix different brands and still

## TURNOUT CONTROL, CONT.

get them all to throw reliably from one panel control.

For complex yard operations, the **SNAPPER™** can be used to align an entire route if a diode matrix is incorporated into the control panel (see the **ACCESSORIES** Section for 3 amp diodes suitable for matrix control). Recycle time of the **SNAPPER™** is virtually instantaneous. The **SNAPPER™** is constructed on a 2" x 3" printed circuit board and includes a section of Printed Circuit Mounting Track (**PCMT**) for simple, snap-in mounting.

800-5303 SNAPPER™ TWIN COIL SWITCH  
MACHINE POWER SUPPLY

### TC-1 TURNOUT CONTROL - TWIN COIL

The **CIRCUITRON TC-1** will provide automatic activation of any twin-coil type switch machine when used in conjunction with a **CIRCUITRON** Detection circuit (the **DT-4** is the usual choice). The **TC-1** has two input control terminals and is to be used to "force" a turnout to a specific direction. One common application of the **TC-1** is to provide a non-derailing function on a trailing point turnout. 2 Opto-Sensors from a **DT-4** are used by placing one on each leg of a turnout a short distance ahead of the frog. A train approaching from either leg will pass over the respective Opto-Sensor, activate the **DT-4**

output sending a control signal to the **TC-1** which will align the turnout so as to prevent a derailment. Pushbuttons may easily be added to the **TC-1** so that manual control is maintained. The **TC-1** can be

powered from a 12-18 volt AC or DC input. Maximum power will be achieved with an 18 volt AC or unfiltered DC input (see information on Capacitor Discharge Circuits on previous page.) The recycle time is 2—3 seconds. The **TC-1** is constructed on a 3" square printed circuit board.

800-5605 TC-1 TURNOUT CONTROL -  
TWIN COIL

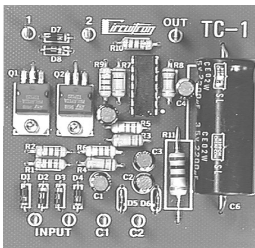

### TC-2 TURNOUT ALTERNATOR - TWIN COIL

The **TC-2** has identical output capabilities to the **TC-1** above. However, the **TC-2** has only a single control terminal. Each time the control terminal is activated, the switch machine is thrown to the opposite direction. This alternating action is useful for allowing trains to take alternate routes around a layout automatically. All other specifications are the same as the **TC-1**.

800-5606 TC-2 TURNOUT ALTERNATOR -  
TWIN COIL

### TC-3 TORTOISE TURNOUT CONTROL

The **CIRCUITRON TC-3** functions exactly the same as the **TC-1** above, but the output is designed to drive the **CIRCUITRON TORTOISE™** Switch Machine. The **TC-3** can also be used with Switchmaster™ and other brands of stall-motor switch machines that use the Hankscraft™ display motor. The **TC-3** is ideal for use as a driver when pushbutton control of the **TORTOISE™** is desired such as when used with diode matrix controls. The **TC-3** requires a 12 - 18 volt DC input and is constructed on a 1½" x 3" printed circuit board.



800-5615 TC-3 TORTOISE TURNOUT  
CONTROL

### TC-4 TORTOISE DIRECTION ALTERNATOR

The **TC-4** is identical in function to the **CIRCUITRON TC-2** above, except that the output of the **TC-4** is designed to drive the **CIRCUITRON TORTOISE™** Switch Machine. The **TC-4** can also be used with Switchmaster™ and other brands of stall-motor switch machines that use the Hankscraft™ display motor. The **TC-3** requires a 12 - 18 volt DC input and is constructed on a 1½" x 3" printed circuit board.

800-5616 TC-4 TORTOISE DIRECTION  
ALTERNATOR

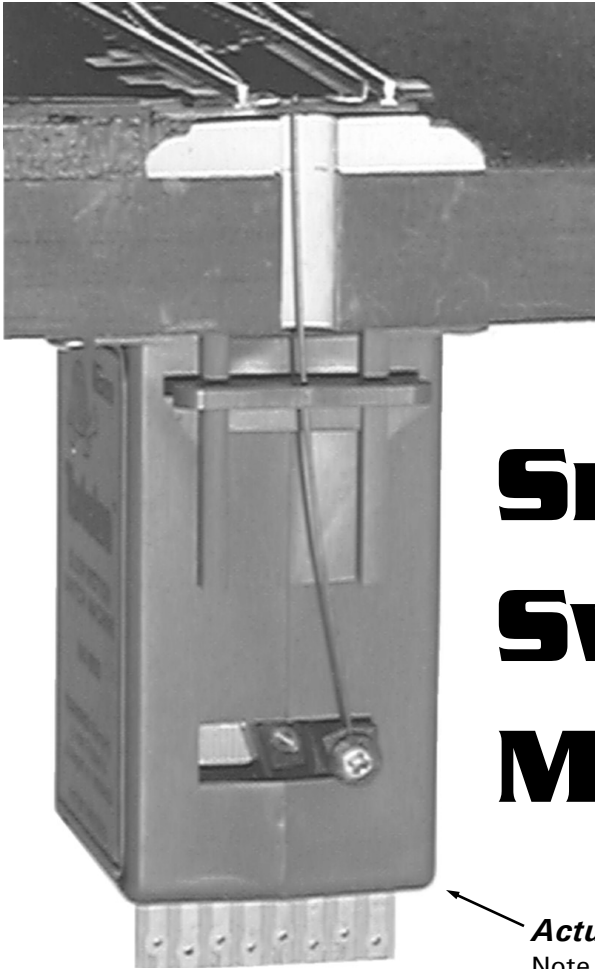

# Tortoise™

Simply...  
**the BEST!**

## SLOW-MOTION SWITCH MACHINE

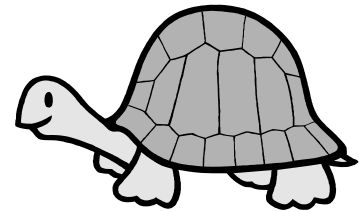

*Actual Size Photograph*  
Note Extremely Simple Mounting  
and Linkage (included).

**Part No.**  
**800-6000**  
VALUE PACKS  
6-Pack 800-6006  
12-Pack 800-6012

## FEATURES

- **PATENTED, ADVANCED TECHNOLOGY DESIGN!**  
Lowest Current Drain Switch Machine Available (4 ma. during operation, 15 ma. at stall).  
Motor stalls at each end of throw—  
No Cutoff Contacts Necessary.  
Precision Engineered Gear-Drive Mechanism (superior to screw-drive machines).  
Enclosed Construction.  
Constant Tension on the Switch Points.
- **ULTRA-SIMPLE MOUNTING!**  
No Additional Brackets or Linkage Necessary.  
Fulcrum adjusts for use in all Scales - Z to G.
- **PROTOTYPICAL SLOW MOTION ACTION!**  
3 Seconds to Complete Throw.
- **CONVENIENT AUXILIARY CONTACTS!**  
2 Sets SPDT Provided for Powering the Frog or Signals.
- **SIMPLIFIED WIRING!**
- **ALSO IDEAL FOR GRADE CROSSING GATES AND SEMAPHORES!**
- **UNPRECEDENTED 9 YEAR WARRANTY!**

# Say Hello to the...



DCC ENHANCED  
**SMAIL™**

## SLOW MOTION ACTUATOR WITH INTEGRATED LOGIC

Circuitron, Inc. is pleased to introduce the **SMAIL™**, a DCC enhanced version of our very popular **TORTOISE™ Slow Motion Switch Machine**. Incorporating proven and reliable NCE Switch-It™ decoder technology internally on the **SMAIL™** circuit board, no other accessory decoders are necessary. Compatible with all DCC systems that provide accessory address control. 2 wire connection to track or DCC bus with no external power necessary. May also be controlled with panel switches or detection circuits. Adjustable throw speed and in DC mode, also provides for 3 position semaphore driving or crossing gate actuation. Edge connector solder pad terminals for wiring are standard. Optional models include factory installed screw-type terminal blocks.

800-6200	<b>SMAIL™</b>
800-6200TB	<b>SMAIL™ w/Term. Blocks</b>
800-6206	<b>Value Pack of 6</b>
800-6206TB	<b>Value Pack w/Term. Blocks (6)</b>
800-6212	<b>Value Pack of 12</b>
800-6212TB	<b>Value Pack w/Term. Blocks (12)</b>



# TORTOISE™ AND SMAIL™ ACCESSORIES

Accessories may be used with either the TORTOISE™ or the SMAIL™

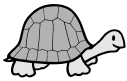

## Tortoise™

### RTM REMOTE TORTOISE™ MOUNT

The **CIRCUITRON Remote Tortoise™ Mount** consists of a molded base mechanism to which the TORTOISE™ (not included) is mounted. An adjustable lever arm is fastened onto the TORTOISE™ output and drives a stainless steel wire inside a flexible teflon tube, much like a sub-miniature choke cable.

This thin wire attaches to a compact actuator mechanism and is mounted beneath the turnout. It includes a spring wire and brass tube to transmit the motion to the points above. The mounting bracket (with TORTOISE™) may be secured in any position and up to 18" away from the turnout points—even above the layout inside a structure, if desired. The points actuating mechanism requires 1/2" clearance under the turnout sub-roadbed. The **RTM** is fully adjustable for all scales and brands of turnouts.

800-6100 RTM REMOTE TORTOISE™ MOUNT

### EXTRA CABLE AND ACTUATOR FOR RTM

The **CIRCUITRON Remote Tortoise™ Mount** is designed to drive up to 2 cables and actuators at the same time, thus allowing a single TORTOISE™ to actuate two sets of points simultaneously, such as for crossover use.

800-6101 EXTRA CABLE & ACTUATOR –RTM

### TORTOISE™ DRILLING TEMPLATE

A thin, precise laser-cut plastic template for use when multiple TORTOISE™ switch machines are to be installed in the standard under-layout configuration.



800-6190 TORTOISE™ DRILLING TEMPLATE

### RSA REMOTE SIGNAL ACTIVATOR

Mounting bracket and mechanism utilize the TORTOISE™ (not included) and a special drive wire cable assembly to remotely actuate any crossing gate, train order board or upper/lower quadrant semaphore signal having a vertical control wire extending below the layout. Signals of this type include ones manufactured by NJ International, Tomar and others. There are fully adjustable, precise, stops provided at both ends of travel for excellent repeatability. The total travel can be adjusted between 0.1" and 0.7" for use in all scales. Can drive 2 cables from the one mechanism, if desired, for dual crossing gate installations. 3 position Semaphore control can be achieved with the addition of the SD-2 Semaphore Driver (see page 26).

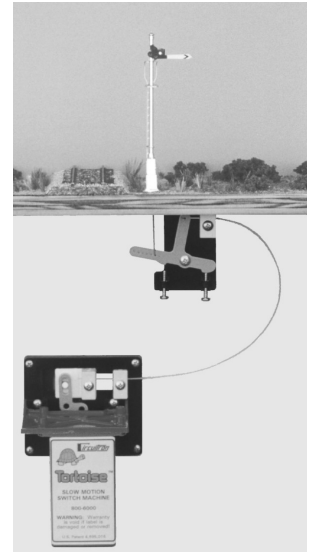

800-8100 RSA REMOTE SIGNAL ACTIVATOR  
800-8101 EXTRA CABLE & ACTUATOR –RSA



THE RSA CAN ALSO BE EASILY ADAPTED TO ACT AS A REMOTE CAR STOP ON INCLINED TRACKAGE.

### AC ADAPTER

110 volt AC wall plug adapter outputs filtered 12 volts DC at up to 500 milliamps of current. Sufficient to power up to 30 TORTOISE™ Switch Machines.

Also ideal for power many of CIRCUITRON electronic circuits when a filtered DC power source is specified.



800-7212 AC ADAPTER

# INTERFACE CIRCUITS

**CIRCUITRON**'s products have been designed to be as versatile as possible, and no additional circuitry is required for most applications (including connecting the outputs to computers). However, there may be times when a **CIRCUITRON** device is to be used with another manufacturer's product which is not directly compatible. For these situations, we provide the **CIRCUITRON** Logic Translator Circuits which will allow you to connect "positive logic" (those circuits that provide a positive voltage output) to the **CIRCUITRON** devices which utilize "negative logic" (active 'low').

**NOTE:** IF YOU NEED TO DRIVE *EXTRA-HEAVY* LOADS OR AC DEVICES OFF A **CIRCUITRON** OUTPUT, CONSIDER USING ONE OF OUR EXTERNAL RELAY CIRCUITS (SEE THE **TRAIN CONTROL CIRCUITS** SECTION)

## LT-1, LT-2 LOGIC TRANSLATOR CIRCUITS

The **CIRCUITRON** LT-1 and LT-2 are interface circuits that allow **CIRCUITRON** products to function with other manufacturer's products that require opposite polarity from **CIRCUITRON** products. Both boards have 4 independent logic inverter circuits on the one board. Both the LT-1 and the LT-2 are constructed on 1½" x 3" printed circuit boards.

**LT-1** — Converts the grounded (-) output of any **CIRCUITRON** product to a positive voltage. Requires a 6 - 24 volt DC power source for the circuit. The output voltage will be essentially equal to the power supply and the output capacity is up to 250 ma.

**LT-2** — Takes a positive (+) output signal from an external source (such as another manufacturer's product) and converts it to the negative (ground or -) signal required by

**CIRCUITRON** products' "Control" or "Trigger" input terminals. The same DC power source (may be 6 - 24 volts DC) being used to power the **CIRCUITRON** products should be used for the LT-2. 250 ma. output capacity.

800-5271 LT-1 LOGIC TRANSLATOR - POSITIVE OUTPUT  
800-5272 LT-2 LOGIC TRANSLATOR - NEGATIVE OUTPUT

## PB-1 POWER BOOSTER CIRCUIT

The outputs on most all **CIRCUITRON** devices are capable of controlling a maximum DC load of about 250 ma. Exceeding this rating will likely cause damage or destruction of the output transistors. In situations where you need to control a higher current DC device such as a motor or heavy relay coil, the **CIRCUITRON** PB-1 will connect simply to the output terminal and raise the current controlling capacity to 1 amp. The PB-1 output connects to negative ( - or ground), just like the output it is connected to. The PB-1 presents a negligible load on the output it is connected to as the control current is only a few milliamperes. The PB-1 is constructed on a 2" x 3" printed circuit board and requires a 6 - 24 volt DC power source.

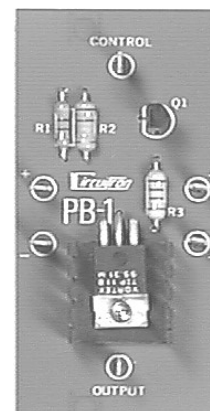

800-5603 PB-1 POWER BOOSTER CIRCUIT

## CAUTION

THE OUTPUTS ON MOST ALL **CIRCUITRON** PRODUCTS ARE DESIGNED TO CONTROL *ONLY* DC POWERED DEVICES AND CIRCUITS.

IF YOU NEED TO CONTROL AN AC POWERED DEVICE SUCH AS A LIONEL ACCESSORY, YOU WILL HAVE TO USE A RELAY ON THE **CIRCUITRON** OUTPUT TO PROVIDE THE NECESSARY ISOLATION. SEE THE **TRAIN CONTROL CIRCUITS** SECTION FOR THE LISTING OF **CIRCUITRON**'S EXTERNAL RELAY CIRCUITS.

# POWER SUPPLIES

Although most **CIRCUITRON** products are designed to operate off a wide range of AC or DC input voltages, the most consistent and reliable operation will be achieved when a dedicated DC power source is used. You may use the accessory terminals of a power pack to power **CIRCUITRON** electronics, but we do not recommend it if you are also using the pack to power trains. Virtually all power packs have a single internal transformer, and *both* the track power and the accessory power are derived from this same source. If a locomotive generates a voltage spike as it crosses a turnout, it is possible for that spike to travel back to the power pack and out the accessory terminals. If you have any doubt about the nasty spiking tendency of model railroad locomotives, try this experiment: ***Don't try this if you wear a pacemaker!*** Stick your favorite locomotive on an isolated section of track and hold it in place while you apply half throttle power. Now, rest your free hand lightly on the track behind the loco. Stall the motor momentarily by pressing down on the model and then rock it to one side so that the wheels break contact with the track. Actually, maybe you should just take our word for it. We have measured the inductive kick (spike) from an Athearn locomotive at 3,000+ volts. Needless to say, our electronic circuits are not fond of dealing with this type of surge, so we recommend that you use a *SEPARATE* power source for your electronic products. There are a number of ways to provide this DC source:

- 1) Design and build your own (excellent choice for the electronics knowledgeable hobbyist).
- 2) Purchase a ready-made supply (see our AC Adapter on Page 35).
- 3) Use a **CIRCUITRON** converter to adapt an unused power pack output.

All power supplies (and power packs) are rated by their output capacity as measured in volts and amperes. The total capacity is usually given on the nameplate and will likely be a VA (volt-ampere) rating equal to the voltage times the current in amperes at maximum output. This is also equal to Watts of output. Thus a 24 VA transformer might have a 12 volt output at 2 amps, or it might supply 18 volts at 1.33 amps output (it can't do both!). Keep in mind that the total VA of a power pack will

be divided between the track terminals and the accessories terminals, and that if you connect a lot of accessories to a pack, you may not have enough power left over to run a train.

The current draw of **CIRCUITRON** products is not listed here in this catalog, but as a general rule, most of our Detection Circuits and lighting circuits will draw about 20 - 30 milliamps, and circuits with relays such as the **AR-1** will draw about 60 - 70 ma. You are probably safe connecting between 15 and 20 of our products to a 1 amp (1,000 ma.) power supply. However, if you are powering lamps or LEDs off the circuits (and using the same power source for them), you will have to allow an additional 40 - 70 ma. for *each* lamp, and about 15 ma. for each LED. As you can see, it is quite easy to exceed a 1 amp supply's capacity with just a handful of additional lamps. *NOTE: Exceeding a transformer's rating by connecting too many accessories, lamps or circuits to it will drop the output voltage below its recommended rating, and will cause excessive heat in the transformer, likely destroying it in the long run.*

### ***What the heck is "Filtered" and why isn't my power pack "Regulated"?***

Throughout this catalog, you may find references to the above terms. The output of most power packs is **UN**-regulated, **UN**-filtered DC. The accessory terminals may be AC or DC, and they will also be unregulated and unfiltered. The term "Filtered" is used with reference to a DC power source and it means that a smoothing capacitor and/or choke is used to even out the peaks and valleys of the normal DC output. When filtered, the output approaches a smooth DC level, similar to what would be supplied by a battery source. Now, an unfiltered DC source has an output that rises to a peak level and returns to zero 60 or 120 times a second. However, when a capacitor is connected to an unfiltered DC source, the capacitor will charge to the "peak" value, typically about 1.4 times the DC reading you will get on your voltmeter. This peak charging of the filter capacitor will result in a filtered output that will vary in voltage depending on the load applied. A voltage "Regulator" is a device designed to take a higher input voltage and convert it to a very

## POWER SUPPLIES, CONT.

stable fixed lower voltage regardless of the load applied (within the device's ratings, of course). **CIRCUITRON** offers both Filter and Regulator circuits for many applications.

### PS-1 FILTERED AC TO DC CONVERTER



The **CIRCUITRON PS-1** is an AC to DC converter that will provide a filtered 1 amp DC output from an AC or unfiltered DC source. Input voltages can range from 2 to 22 volts. Since the **PS-1** is an unregulated power supply, the output will vary depending upon input voltage and the output load. Approximate output voltages for various conditions can be found in the graph.

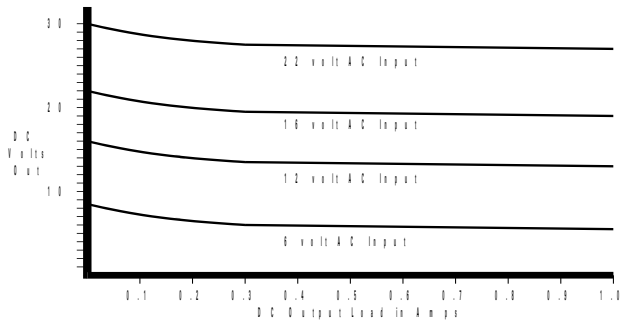

Keep in mind that these values are for an input voltage that remains constant independent of load. The transformer used to power the **PS-1** must be capable of supplying the rated voltage input at the load you will be applying. A section of **PCMT**, **CIRCUITRON's** Printed Circuit Mounting Track, is provided for simple, snap-in mounting of the **PS-1**. The **PS-1** is constructed on a 2" x 3" printed circuit board.

800-5301 PS-1 FILTERED AC TO DC  
CONVERTER

### PS-2 REGULATED AC TO DC CONVERTER - 12 VOLT

The **CIRCUITRON PS-2** is an AC to DC converter and voltage regulator that will provide a constant 12 volt DC output under varying load conditions and/or variations in input voltage. The **PS-2** has a maximum output of 1 amp and a maximum input voltage of 18 volts AC. Note: The **PS-2** will achieve

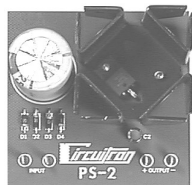

maximum output capacity if the input voltage is 14 volts. Higher voltages may result in a reduction in output current capacity. If the supply voltage is *less* than 14 volts, the output voltage may not stay *Regulated* and may drop below 12 volts, especially at higher current draws. The **PS-2** is constructed on a 3" square printed circuit board, and a section of **CIRCUITRON's** Printed Circuit Mounting Track (**PCMT**) is provided for simple, snap-in mounting.

800-5302 PS-2 REGULATED AC TO DC  
CONVERTER - 12 VOLT

### PS-2A ADJUSTABLE AC TO DC CONVERTER AND REGULATOR

The **CIRCUITRON PS-2A** is a self-contained AC to DC converter with an adjustable voltage regulated output which can be set anywhere between 1.25 and 12.00 volts DC. The output of the **PS-2A** is ideal for powering any low voltage accessories including 1.3 - 1.5 volt micro-lamps (see our **MITEY LITES™** section). The AC or unfiltered DC input to the **PS-2A** should be a minimum of 3 - 5 volts higher than the desired DC output but must not exceed 18 volts. The **size is the same as the PS-2**, and a section of **CIRCUITRON's** Printed Circuit Mounting Track (**PCMT**) is provided for simple, snap-in mounting.

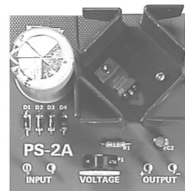

800-5305 PS-2A ADJUSTABLE AC TO DC  
CONVERTER /REGULATOR

### PS-3 EMERGENCY FLASHER POWER SUPPLY

The **PS-3** is designed to power the **CIRCUITRON EF-1** Emergency Flashers in situations where battery operation is undesirable. The **PS-3** can also be used to power 9 volt flashers off of track power on layouts utilizing Command Control. The **PS-3** accepts either an AC or DC input of 10-18 volts and regulates it to 9 volts DC. The 50 milliamp output can power up to 5 **EF-1s** at once. The **PS-3** measures 0.6" x 1" x .4".



800-5304 PS-3 EMERGENCY FLASHER POWER  
SUPPLY

# SOUND

## SS-1 STEAM SOUND KIT

# Discontinued



The **CIRCUITRON SS-1** Steam Sound Kit is an easy to connect, low cost, highly realistic steam sound generator that can be installed in HO Scale or larger models. The **SS-1** is

completely self-contained and is powered by a 9 volt "transistor" type battery. There are no connections to the track and thus the **SS-1** may be used with any form of track power including AC, DC, Command or Radio Control. The **SS-1** consists of a 1" x 1" x 0.5" circuit board, 9 volt battery holder, subminiature slide switch, 1" diameter round high output speaker, volume control resistors, chuff contact wire and insulating material (additional materials available in **ACCESSORIES** section), as well as complete, detailed instructions on the various methods of installation. *NOTE: The **SS-1** requires soldering skills as well as standard modeling hand tools for installation.* The sound produced by the **SS-1** is incredible for the low cost of the unit. The sophisticated circuitry has individually controlled attack and decay characteristics for the chuff sound which is synchronized with the wheel rotation to accurately simulate the prototype. In addition, the **SS-1** has a constant background "steam hiss" that provides an authentic sound to the standing locomotive. The **SS-1** has a built in "reverb" effect that adds depth and coloration to the sound.



800-4000 SS-1 STEAM SOUND KIT

## DH-1 DIESEL HORN CIRCUIT

The **CIRCUITRON DH-1** is a highly realistic, all electronic diesel air horn simulator. The three frequencies reproduced by the **DH-1** closely match those produced by the Leslie Company's famous S-3L

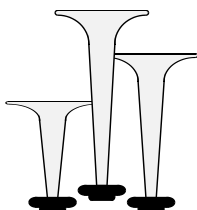

Supertyfon air chime. Each chime on the **DH-1** is individually controllable so that many different tone combinations are possible. It is, in fact, possible to produce seven different horns using just the one **DH-1** circuit board. These would be as follows: single low tone, single middle tone, single high tone, low-middle dual chime, low-high dual chime, middle-high dual chime, and the low-middle-high 3 chime horns. These various combinations are switch selectable. With the addition of extra speakers, these various tones can be produced a t

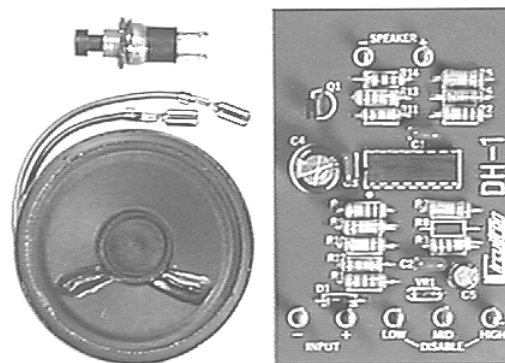

any point on a layout. The **DH-1** is constructed on a 2" x 3" printed circuit board and includes a 2" or 2 1/4" speaker and pushbutton. The speaker will need to be mounted in a baffled enclosure for maximum sound output. Larger speakers may be substituted, if desired. The use of a 5 inch diameter or larger speaker (8 ohm) will greatly increase the volume and improve the sound of the unit. The **DH-1** requires a 10-18 volt AC or DC input for proper operation. Please note that the **DH-1** is not designed for continuous operation. Use of lower voltage inputs will minimize the heat produced in the **DH-1** components and allow for extended on time without harm.

800-5701 DH-1 DIESEL HORN - 3 CHIME

## DH-2 DIESEL HORN CIRCUIT - DIGITALLY RECORDED

[RESERVED FOR PRODUCT UNDER DEVELOPMENT]

## BR-1 BELL RINGER CIRCUIT

SEE LISTING IN **GRADE CROSSING CIRCUITS** SECTION

# LIGHTING CIRCUITS AND SUPPLIES

## PL-8, PL-12 PROGRESSIVE LAMP CIRCUITS

The **CIRCUITRON PL-8** and **PL-12** circuits are used for moving sign-board applications. The sequence for both circuits is the same; only the maximum number of letters (and thus lamps) is different. Either circuit will light signs with fewer than the maximum letters without modifications to the circuit. The Progressive Lamp sequence lights each lamp in succession with all previous lamps remaining on until all lamps are lit. The step speed of the succession is adjustable. All lamps then remain on for a time period (adjustable). Then all the lamps go out for a set time period (adjustable). Finally, all the lamps come on together for a short time (adjustable) and then all go out. The sequence then repeats. The **PL-8** and **PL-12** include 8 and 12 lamps respectively (12 volt, 3 mm dia.) but other size and voltage lamps may be substituted for specific applications. Construction of the

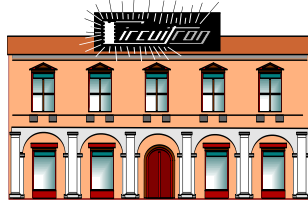

actual sign will depend upon the application and is left to the modeler. The **PL-8** and **PL-12** are constructed on 3" square printed circuit boards and require a 14 - 18 volt AC or DC supply.

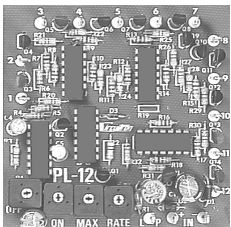

800-5808 PL-8 PROGRESSIVE LAMP CIRCUIT

800-5812 PL-12 PROGRESSIVE LAMP CIRCUIT

## TL-1 TRAFFIC LIGHT CONTROLLER

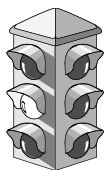

The **TL-1** provides the timing circuitry to accurately reproduce the standard US style four step traffic light sequence. The outputs will drive LED or incandescent lamp signals (not included). If LED signals are used, they must be common anode (+) design. All four time periods are individually adjustable. The **TL-1** is constructed on a 3" square printed circuit

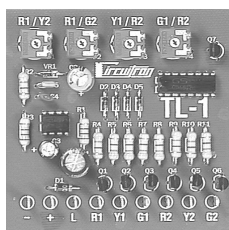

board and requires a 10-18 volt AC or DC input. Standard red, yellow and green outputs are provided for each direction (6 total) and each can drive a 250 ma. maximum load. Companion signals are manufactured by Busch and others. The **TL-1** will directly replace the Busch European sequence flasher.

800-5820 TL-1 TRAFFIC LIGHT CONTROLLER

THE **TL-1** CAN BE USED TO POWER 4 HIGH INTENSITY LAMPS AND USED WITH FIBER OPTICS TO PROVIDE A 4-STEP "THEATER MARQUEE" STYLE CHASE LIGHT.

## CL-1, CL-2 CHASE LIGHT CIRCUITS - 10 STEP

The **CIRCUITRON CL-1** and **CL-2** Chase Light Circuits provide a 10 step lighting sequence

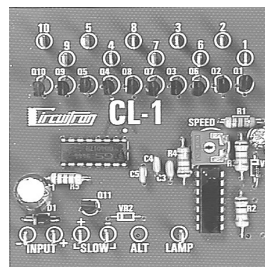

with one lamp lit at a time. This is ideal for any "rotating" signage applications where a single light appears to race around the perimeter of a sign. The **CL-1** includes 10 high intensity 1.4 mm

diameter micro-lamps and works well in HO scale and larger for direct viewing. The **CL-2** includes 2.4 mm lamps and can be used in larger scales for direct viewing or Fiber Optics (see **INDEX**) can be used along with the **CL-2** lamps for marquee applications in the smaller scales. The Fiber Optics are not included, and the lamps are not interchangeable between the **CL-1** and **CL-2**. The circuits provide an adjustable step speed and will operate off 10-18 volt AC or DC power supplies. An additional output is provided to flash backlighting lamps (not included) for the sign or marquee. This output will be ON for the first five lamps in the sequence and OFF for the last five lamps, thereby providing a slow background flash that will be synchronized with the chase action. The **CL-1** and **CL-2** are constructed on a 3" x 3" printed circuit board.

800-5831 CL-1 CHASE LIGHT W/ 1.4MM MICRO-LAMPS

800-5832 CL-2 CHASE LIGHT W/2.4MM LAMPS

## LIGHTING CIRCUITS AND SUPPLIES, CONT.

### SQ-8 SEQUENCING STROBE CIRCUIT

The **CIRCUITRON SQ-8** provides a rapid sequencing of 8 high intensity white strobe lamps (included). When the lamps are arranged in a linear fashion, the effect is one of a light sweep from one end to the other. This type of lighting effect is commonly used near airports on the approach towers but can also be very effective on signs and other applications. Both the sweep speed and the delay between sweeps are independently adjustable. The **SQ-8** is constructed on a 3" x 3" printed circuit board and requires a 10 - 18 volt AC or DC input.

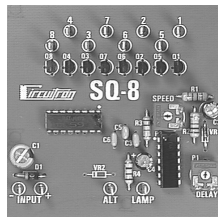

800-5838 SQ-8 SEQUENCING STROBE

### AW-1, AW-2 ARC WELDER CIRCUITS

The **CIRCUITRON** Arc Welder Circuits utilize 2 lamps, one yellow and one blue, along with a circuit that provides a random flickering effect of the lamps. The result is a very convincing representation of an arc welder in operation. The **AW-1** includes 1.4 mm diameter micro-bulbs and is designed for direct viewing in all scales. A small wisp of cotton placed over the lamps will serve to diffuse the light and produce a very realistic smoke effect. The **AW-2** includes 2.4 mm diameter lamps and should be used to illuminate a window from within a structure. If the window is frosted to represent years of grime, the flickering effect is extremely realistic. Either circuit may be used with only the yellow lamp if only a flickering flame effect is desired (however, our **FIRELITES™** circuits are more suitable for this task). The **AW-1** can only power the lamps supplied with it, but the **AW-2** can power up to a total of 20 lamps for large structures or use in multiple buildings. Clear lamps are also available from **CIRCUITRON** in our **MITEY LITES™** line which may be dyed to

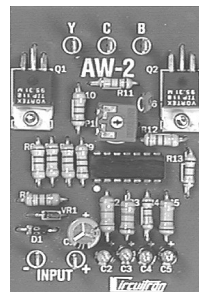

any color for other applications (amber, orange and yellow make a *very* convincing campfire but, again, the **FIRELITES™** circuits may be more suitable). Order #7416 lamps for the **AW-1** and 800-9341 for the **AW-2**. Replacement blue and yellow lamp sets are also available. The **AW-1** and **AW-2** are constructed on 2" x 3" printed circuit boards and require a 10-18 volt AC or DC input for proper operation.

800-5841	AW-1	ARC WELDER W / 1.4 MM MICRO-LAMPS
800-5842	AW-2	ARC WELDER W / 2.4 MM LAMPS
800-9342	REPLACEMENT LAMP SET FOR AW-1	
800-9343	REPLACEMENT LAMP SET FOR AW-2	

### FIRELITES™ FLICKERING FLAME CIRCUITS



**FIRELITES™** are realistic, random flickering flame circuits that can be used for campfires, barrel fires, and inside structures. The **FF-1** includes a single 1.4mm amber lamp and is ideal for direct viewing. The **FF-2** includes both amber and yellow 1.4mm lamps (which flicker and flash independently). It provides a very

realistic fire effect for large direct viewed fires or when placed inside a barrel or large bonfire and used to illuminate pieces of crinkled up cellophane. The **FF-3** is a high power unit which includes amber and yellow 2.4 mm lamps and can be used for a backlighting effect inside of structures. Up to 20 lamps total (see below) can be powered by one **FF-3** for use in multiple locations or to simulate one large fire. 10-18 volt AC or DC input.

800-5851	FF-1	FIRELITES™ CIRCUIT
800-5852	FF-2	FIRELITES™ CIRCUIT
800-5853	FF-3	FIRELITES™ CIRCUIT

### REPLACEMENT / ADDITIONAL LAMP SETS

800-74163-02	FOR FF-1	AMBER, PKG (2)
800-9344	FOR FF-2	AMBER & YELLOW
800-9345	FOR FF-3	AMBER & YELLOW
800-93413-06	FOR FF-3	AMBER, PKG (6)
800-93417-06	FOR FF-3	YELLOW, PKG (6)

## LIGHTING CIRCUITS AND SUPPLIES, CONT.

### FIBER OPTICS

**CIRCUITRON's** Fiber Optics are PMMA plastic fibers with a special fluoro-polymer coating. Light entering the end of a fiber is transmitted along the length by internal reflection and exits the far end with very little loss in intensity. Since virtually no light is emitted from the side of the fiber (unless it is scratched or nicked), painting of the outside of the fiber to prevent light loss is an option but not a necessity (lacquer paints are not recommended since they may etch or melt the fiber). These fibers are very flexible and can be bent to fairly tight radii with little loss in efficiency. A high intensity incandescent lamp or LED may be

used as the light source. If a sufficiently bright source is chosen, a number of fibers may be illuminated from the one source. The fiber is easily cut to length using a razor blade or X-acto™ knife. Use for signals, signs and special effects.

800-8020	FIBER OPTICS, 0.020" DIAMETER 30 FT.
800-8030	FIBER OPTICS, 0.030" DIAMETER 20 FT.
800-8040	FIBER OPTICS, 0.040" DIAMETER 15 FT.
800-8060	FIBER OPTICS, 0.060" DIAMETER 10 FT.
800-7833	FIBER OPTICS MANUAL & PROJECT BOOK

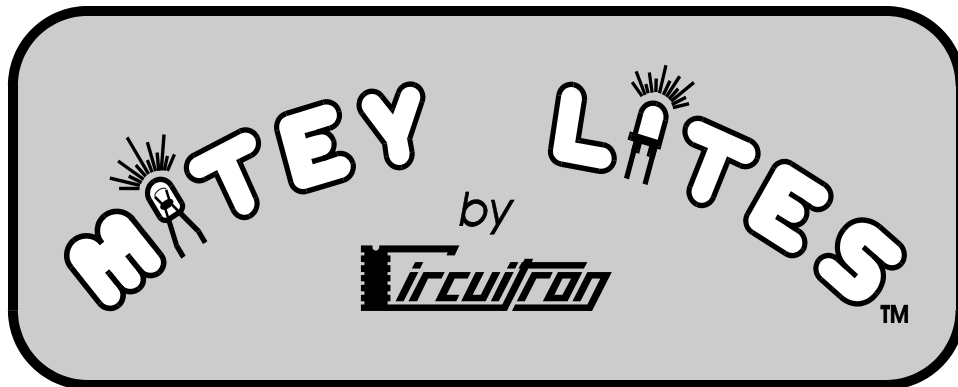

**CIRCUITRON** IS VERY PLEASED TO ANNOUNCE THE RELEASE OF THE **MITEY LITES™** LINE OF INCANDESCENT LAMPS AND LIGHT EMITTING DIODES. THESE ITEMS ARE CUSTOM MANUFACTURED TO OUR STRINGENT SPECIFICATIONS AND PROVIDE HIGH QUALITY, CONSISTENCY, AND GREAT VALUE. WITH THE WIDEST RANGE OF PHYSICAL SIZES, VOLTAGE AND BRIGHTNESS RATINGS IN THE INDUSTRY, THE **MITEY LITES™** LINE WILL EASILY FILL *ALL* OF YOUR MODEL LIGHTING NEEDS. ALL OF OUR INCANDESCENT LAMPS ARE RATED FOR A MINIMUM OF 500 HOURS OF OPERATION AT THEIR SPECIFIED VOLTAGE. SIZE AND RELATIVE BRIGHTNESS CHARTS ARE PROVIDED ON THE FOLLOWING PAGES.

### CAUTION

*Sub-Miniature Lamps and Light Emitting Diodes (LEDs) are fragile and must be handled with care to prevent damage and to avoid premature failure. Incandescent lamps **must** be operated at their rated voltage or less. Even a 10% high voltage applied to a lamp will reduce it's life by 2/3. A 30% over voltage applied to a lamp will result in a life of only 4% of the normal. Thus, running one of our 1.5 volt lamps (which normally have a 500 hour life expectancy) at 2 volts will result in a life of about only 20 hours. If you must power a lamp from a supply rated at a higher voltage than the lamp's, use a suitable rated voltage dropping resistor for **each** lamp. CIRCUITRON has selected resistors available for most lamp models.*

*LEDs must have a suitable value current limiting resistor wired in series with one lead. The value of the resistor will depend on the voltage of the power supply. Use the formula:*

$$(VOLTS - 2) \div 0.015 = RESISTANCE \text{ in ohms}$$

*Choose the closest standard value ½ watt resistor available. Radio Shack is a good source.*



# MINIATURE INCANDESCENT LAMPS

PLEASE READ INFORMATION ON PREVIOUS PAGE

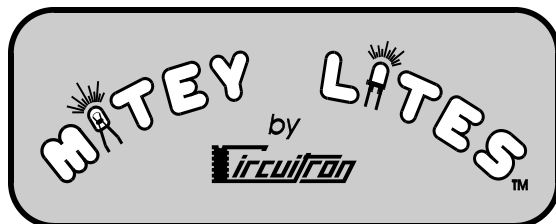

- 1) Sub-Micro, 0.75 mm Diameter, Axial Lead. 1.5 volt, 18 ma. with 1" bare wire leads. Use for marker lights, number boards, step lights, etc.
 

800-7400-02	PKG. 2
800-7400-06	PKG. 6
800-7400-12	PKG. 12
800-9400-12	RESISTOR FOR 12 VOLTS PKG. 10
800-9400-16	RESISTOR FOR 16 VOLTS PKG. 10
  
- 2) Standard Output, Long life Micro-lamp. 1.40 mm Diameter, Lens end w/ 8" black stranded wires. 1.5 volt, 13 ma.
 

800-7411-02	PKG. 2
800-7411-06	PKG. 6
800-7411-12	PKG. 12
800-7411-25	PKG. 25
800-9411-12	RESISTOR FOR 12 VOLTS PKG. 10
800-9411-16	RESISTOR FOR 16 VOLTS PKG. 10
  
- 3) Medium Output, Long life Micro-lamp, 1.40 mm Diameter, Lens End w/8" black wire leads. 1.5 volt, 30 ma. *Bright!*

800-7414-02	PKG. 2
800-7414-06	PKG. 6
800-9414-12	RESISTOR FOR 12 VOLTS PKG. 6
800-9414-16	RESISTOR FOR 16 VOLTS PKG. 6
  
- 4) High Output, Long Life Micro-Lamp. 1.40 mm Diameter, Lens End, w/ 8" black wire leads. 1.5 volts, 50 ma. *Very Bright!* Use for headlights, etc.
 

800-7416-02	PKG. 2
800-7416-06	PKG. 6
800-7416-12	PKG. 12
800-74161-02	ORANGE PKG. 2
800-74161-06	ORANGE PKG. 6
800-74162-02	RED PKG. 2
800-74162-06	RED PKG. 6
800-74163-02	AMBER PKG. 2
800-74163-06	AMBER PKG. 6
800-74164-02	GREEN PKG. 2
800-74164-06	GREEN PKG. 6
800-74165-02	BLUE PKG. 2
800-74165-06	BLUE PKG. 6
800-74167-02	YELLOW PKG. 2
800-74167-06	YELLOW PKG. 6
800-9416-12	RESISTOR FOR 12 VOLTS PKG. 6
800-9416-16	RESISTOR FOR 16 VOLTS PKG. 6

- 5) Very High Output, Long Life Micro-Lamp. 1.40 mm diameter, Lens end with 8" black leads. 3.0 volts, 26 ma. *Extra Bright!* Use for Headlights, Mars Lights or Ditch Lights, etc.
 

800-7418-02	PKG. 2
800-7418-06	PKG. 6
800-9418-12	RESISTOR FOR 12 VOLTS PKG. 4
800-9418-16	RESISTOR FOR 16 VOLTS PKG. 4
  
- 6) Very High Output, Long Life Micro-Lamp. 1.70 mm diameter, Lens end with 8" black leads. 1.5 volts, 75 ma. *Extra Bright!* Great for Headlights, Mars Lights or Ditch Lights, etc.
 

800-7421-02	PKG. 2
800-7421-06	PKG. 6
800-9421-12	RESISTOR FOR 12 VOLTS PKG. 4
800-9421-16	RESISTOR FOR 16 VOLTS PKG. 4
  
- 7) Extra High Output, Long Life Micro-Lamp. 1.70 mm diameter, Lens end with 8" black leads. 3.0 volts, 105 ma. *Extremely Bright!* Great for Headlights, Mars Lights or Ditch Lights, etc.
 

800-7424-02	PKG. 2
800-7424-06	PKG. 6
800-9424-12	RESISTOR FOR 12 VOLTS PKG. 4
800-9424-16	RESISTOR FOR 16 VOLTS PKG. 4
  
- 8) Very High Output, Long Life Micro-Lamp. 2.40 mm diameter, Lens end with 8" black leads. 1.5 volts, 90 ma. *Extra Bright!* Use for Headlights, Mars Lights or Ditch Lights, etc.
 

800-7426-02	PKG. 2
800-7426-06	PKG. 6
800-9426-12	RESISTOR FOR 12 VOLTS PKG. 4
800-9426-16	RESISTOR FOR 16 VOLTS PKG. 4
  
- 9) Brilliant Output, Long Life Micro-Lamp. 2.40 mm diameter, Lens end with 8" black leads. 3.0 volts, 120 ma. *Extremely Bright!* Use for Headlights, Mars Lights or Ditch Lights.
 

800-7428-02	PKG. 2
800-7428-06	PKG. 6
800-9428-12	RESISTOR FOR 12 VOLTS PKG. 4
800-9428-16	RESISTOR FOR 16 VOLTS PKG. 4

# MINIATURE INCANDESCENT LAMPS

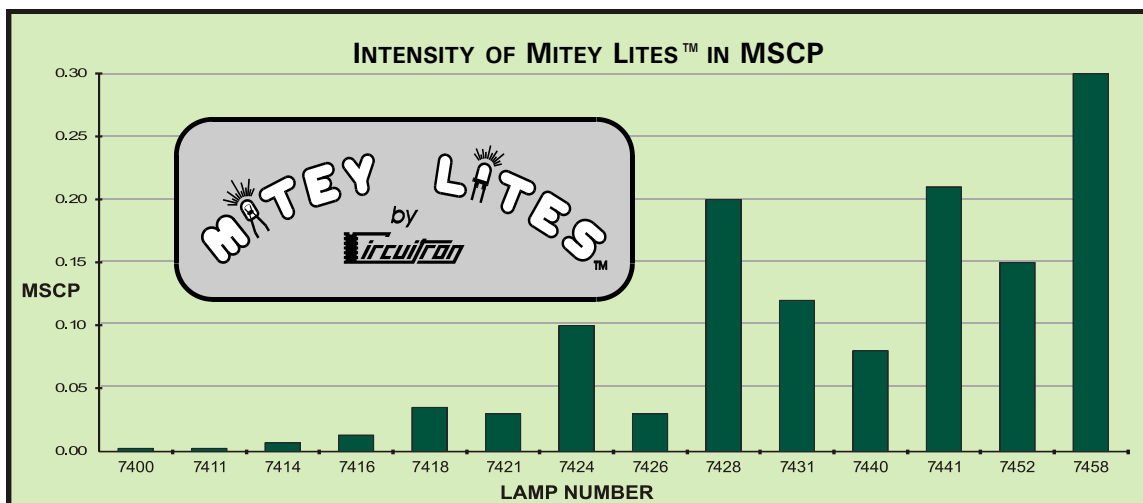

**PLEASE READ INFORMATION ON PAGE 41**

**10)** Extra High Output, Long Life Micro-Lamp. 2.40 mm diameter, Lens end with 8" black leads. 12.0 volts, 50 ma. *Extremely Bright!* Use for Headlights, Mars or Ditch Lights, etc. with direct track power or command control.

800-7431-02	PKG. 2
800-7431-06	PKG. 6

**11)** General Purpose, Long Life Miniature Lamp. 3.0 mm Diameter with Black 12" wire leads. 14 - 16 volts, 30 ma. Use for equipment and structure lighting.

800-7440-06	PKG. 6
800-7440-12	PKG. 12
800-7440-25	PKG. 25

**12)** High Output version of 7440 (2.5 times brighter) 14-16 volts, 60 ma. 3.0 mm Diameter with Brown 12" wire leads. Use for equipment and structure lighting.

800-7441-06	PKG. 6
800-7441-12	PKG. 12
800-7441-25	PKG. 25

**13)** 3.0 mm diameter with plug-in style, short, stiff leads. 5.0V, 60 ma. Ideal replacement lamp for LGB™ in-car and loco lighting applications.

800-745202	PKG. 2
800-745206	PKG. 6
800-745212	PKG. 12

**14)** 3.0 mm diameter with plug-in style, short, stiff leads. 18–22V, 45 ma. Ideal replacement lamp for in-car and loco DCC lighting applications.

800-745802	PKG. 2
800-745806	PKG. 6
800-745812	PKG. 12

**MISCELLANEOUS REPLACEMENT LAMPS:**

**15)** Replacement Lamp for ML-1 Mars Light. Dual filament design. 4 mm diameter, Lens End. High intensity output. Each filament: 3.0 volts, 100 ma. Three 8" lead wires.

800-9340	PKG. 1
----------	--------

**16)** Replacement Lamp Set for FLA Amtrak Strobe. Can also be used with **AW-2** Arc Welder Circuit and dyed to any color. 2.4 mm diameter. 5.0 volts, 20 ma. 8" long lead wires.

800-9341	PKG. 2
----------	--------

**17)** Replacement Lamp Set for AW-1 Arc Welder Circuit. 1.4 mm diameter. 1.5 volts, 50 ma. 8" wire leads. One blue and one yellow lamp per package.

800-9342	PKG. 2
----------	--------

**18)** Replacement Lamp Set for AW-2 Arc Welder Circuit. 2.4 mm diameter. 5.0 volts, 20 ma. 8" wire leads. One blue and one yellow lamp per package.

800-9343	PKG. 2
----------	--------

**19)** Replacement Lamp Set for FIRELITES™ FF-1

800-74163-02	AMBER, PKG. 2
--------------	---------------

**20)** Replacement Lamp Set for FIRELITES™ FF-2

800-9344	AMBER & YELLOW, 1 EACH
----------	------------------------

**21)** Replacement Lamp Set for FIRELITES™ FF-3

800-9345	AMBER & YELLOW, 1 EACH
800-93413-06	AMBER, PKG. 6
800-93417-06	YELLOW, PKG. 6

# LIGHT EMITTING DIODES (LEDs)

MITEY LITES™ Light Emitting Diodes are among the brightest diffused lens LEDs currently available. They are offered in a wide variety of colors and sizes and are ideal as replacement units for Strobe Flashers, Signals, etc. Our Super Bright LEDs offer up to 50 times the light output of general purpose LEDs while our Hyper-Brite™ LEDs are up to 500 times brighter than general purpose LEDs.

**CAUTION:** All LEDs MUST have a suitable value current limiting resistor wired in series with one of the power leads. Use the formula:  $(VOLTS - 2) \div 0.015 = RESISTANCE$  in ohms  
LEDs require a DC power source. Using an AC supply may damage or destroy LEDs.

## SUPER BRIGHT LIGHT EMITTING DIODES

3 mm (.12")



800-9301	ORANGE	PKG. 2
800-9302	RED	PKG. 2
800-9303	YELLOW / AMBER	PKG. 2
800-9304	GREEN	PKG. 2
800-9306	BI-COLOR RED/GRN	PKG. 1

5 mm (.20")



800-9311	ORANGE	PKG. 2
800-9312	RED	PKG. 2
800-9313	YELLOW	PKG. 2
800-9314	GREEN	PKG. 2
800-9316	BI-COLOR RED/GRN	PKG. 1

2 mm (.080")

Axial Lead Package with a 0.1" square base and a 2 mm round dome



800-9321	ORANGE.	PKG. 2
800-9322	RED	PKG. 2
800-9323	YELLOW	PKG. 2
800-9324	GREEN	PKG. 2

## HYPER-BRITE™ LIGHT EMITTING DIODES



3 mm diameter special short flangeless package. Limiting resistors for use with 12-16 volt supplies are included.

### 7501 WHITE

Special resin reduces bluish output and provides incandescent look. Great Headlights!

800-7501-01	PKG. 1
800-7501-02	PKG. 2
800-7501-06	PKG. 6

### 7502 RED

Diffused package for wide-angle viewing. Great for strobes, signals and traffic lights!

800-7502-02	PKG. 2
800-7502-06	PKG. 6

### 7503 ORANGE

Diffused, wide-angle viewing. Great strobes!

800-7503-02	PKG. 2
800-7503-06	PKG. 6

### 7504 PURE GREEN

Diffused, wide-angle viewing. Intense, deep green for signal or traffic light use.

800-7504-02	PKG. 2
800-7504-06	PKG. 6

### 7505 BLUE

Diffused package for wide-angle viewing. Great for emergency vehicles.

800-7505-02	PKG. 2
800-7505-06	PKG. 6

### 7507 YELLOW/AMBER

Diffused package for wide-angle viewing. Deep yellow for signal or traffic light use.

800-7507-02	PKG. 2
800-7507-06	PKG. 6

### CAUTION

INCANDESCENT LAMPS AND LIGHT EMITTING DIODES ARE FRAGILE DEVICES THAT ARE EASILY BURNED OUT OR BROKEN. **PLEASE BE CAREFUL!**

**CIRCUITRON** DOES NOT WARRANT THESE PRODUCTS AGAINST BREAKAGE OR FAILURE.

# ACCESSORIES

## SLIDE SWITCHES

**CIRCUITRON** offers both SPDT and DPDT sub-miniature slide switches for use in models or other locations where an extremely compact switch is needed. The switches are rated at 1 amp.

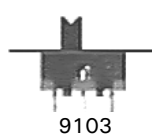

800-9103 SPDT PKG. 2  
800-9123 DPDT PKG. 2

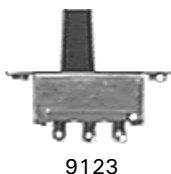

## TOGGLE SWITCHES

A wide variety of miniature, panel mount toggle switches are now available from **CIRCUITRON**. These switches are rated at 5 amp switching capacity and will fit in a 1/4" panel hole. They have solder lug terminals and can be used for many modeling applications. The switches have standard chrome bat handles, and color coding handle sleeves are available as an option.



*Actual Size*



800-9110-02	SPDT	ON-ON	PKG. 2
800-9110-06	SPDT	ON-ON	PKG. 6
800-9111-02	SPDT	ON-OFF-ON	PKG. 2
800-9111-06	SPDT	ON-OFF-ON	PKG. 6
800-9112-02	SPDT	ON-OFF-ON MOMENTARY	PKG. 2
800-9112-06	SPDT	ON-OFF-ON MOMENTARY	PKG. 6
800-9120-02	DPDT	ON-ON	PKG. 2
800-9120-06	DPDT	ON-ON	PKG. 6
800-9121-02	DPDT	ON-OFF-ON	PKG. 2
800-9121-06	DPDT	ON-OFF-ON	PKG. 6
800-9122-02	DPDT	ON-OFF-ON MOMENTARY	PKG. 2
800-9122-06	DPDT	ON-OFF-ON MOMENTARY	PKG. 6
800-9128	RED PLASTIC SLEEVE FOR HANDLE		PKG. 6
800-9129	BLACK PLASTIC SLEEVE FOR HANDLE		PKG. 6

## STEAM SOUND KIT PARTS

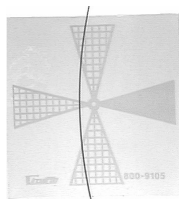

Replacement spring pickup wire and insulation sheets are available for the **SS-1** Steam Sound Kit as are additional 1 inch speakers.

- 800-9104 SPRING PICKUP WIRE - 3" PKG. 4
- 800-9105 MYLAR INSULATING SHEET PKG. 4
- 800-9151 SPEAKER - 1" DIAMETER

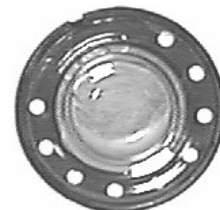

*9151 Speaker Shown Actual Size*

## REPLACEMENT SPEAKER FOR DH-1

- 800-9150 SPEAKER - 2" OR 2 1/4" DIAMETER - 8 OHM

## HEAT SHRINK TUBING

Use to insulate and protect wire connections quickly and easily. Shrinks to half the listed diameter when heated with a match, soldering iron or heat gun. 6 inch lengths.

- 800-8700 ASSORTMENT— INCLUDES 1 PIECE FROM EACH OF THE FOLLOWING SIZES
- 800-8703 3/64" DIAMETER 6 PIECES
- 800-8704 1/16" DIAMETER 6 PIECES
- 800-8706 3/32" DIAMETER 6 PIECES
- 800-8708 1/8" DIAMETER 5 PIECES
- 800-8712 3/16" DIAMETER 5 PIECES

## OPTO-SENSORS



These are the same parts provided with all of **CIRCUITRON's** Detection and Reversing Circuits. They may be used for replacements if the originals become damaged. They may also be used to extend detection to sidings and spurs (see **APPLICATIONS** section).

- 800-9201 OS-1 OPTO-SENSOR PKG. 1
- 800-9202 OS-2 OPTO-SENSOR PKG. 2
- 800-9206 OS-6 OPTO-SENSOR PKG. 6

## ACCESSORIES, CONT.

### DIODES

**CIRCUITRON** offers 1 amp, 3 amp and 6 amp silicon diodes for model railroad projects. Use the 3 amp diodes for matrix control of twin-coil switch machines. The 1 amp diodes are useful for directional locomotive lighting and as voltage dropping devices (0.7 volts per diode). The 3 amp and 6 amp diodes are handy for use on UN-detected blocks in a BD-2 system (see **BLOCK DETECTORS** Section) Use a diode with your AC lamp supply to halve the power and extend the life of your lamps 4000 times.

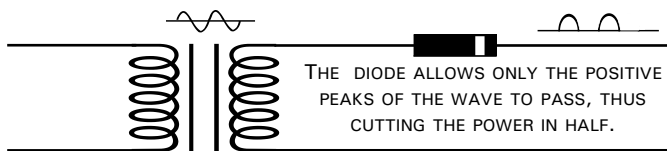

TRANSFORMER OR POWER PACK

800-9350	3 AMP DIODE	PKG. 2
800-9350-12	3 AMP DIODE	PKG. 12
800-9351	1 AMP DIODE	PKG. 6
800-9352	6 AMP DIODE	PKG. 2
800-9352-12	6 AMP DIODE	PKG. 12

### PRINTED CIRCUIT MOUNTING TRACK (PCMT)

**CIRCUITRON's** Printed Circuit Mounting Track is an extruded plastic piece designed to grip and hold any 3" wide printed circuit board. All **CIRCUITRON** products with part numbers between 5000 and 5999 are designed to fit. The **PCMT** can be mounted to the bench or panel with screws, adhesive or double sided tape. The circuit boards snap easily into place and are held firmly by the **PCMT**, yet are easily removed for relocation, etc. The **PCMT** is sold in 6" lengths.



800-9506	PCMT PRINTED CIRCUIT MOUNTING TRACK - 6 INCH
----------	--

### FUSE HOLDER



An inline fuse holder that can be used to protect power supplies, transformers, etc. Fuse not included.

800-9601	FH-1 INLINE FUSE HOLDER
----------	-------------------------

### SOLDERLESS CONNECTORS

These crimp-on female connectors are designed to mate with the .110" x .032" male disconnect tabs used on all **CIRCUITRON** 5000 series circuits and may be used for all applications where it is desired to avoid soldering to the tabs.

800-9602	QCN SOLDERLESS CONNECTOR—NON-INSULATED	PKG. 8
800-9603	QCI SOLDERLESS CONNECTOR - INSULATED	PKG. 6



### PUSHBUTTON

Same pushbutton as supplied with the **DH-1** Diesel Horn, these normally open switches can control up to 1 amp and may be used for turnouts, accessories, etc. ¼" panel hole.



800-9610	PBTN PUSHBUTTON
----------	-----------------

### HOOKUP WIRE—ULTRAFINE

Ultrafine stranded wire measures just 0.015" (0.4 mm) outside diameter. Vinyl insulation is easily stripped. Ideal for wiring locomotive lights, signals, signs and other small models. 10 foot length.

800-8610	BLACK ULTRAFINE WIRE
800-8612	RED ULTRAFINE WIRE
800-8619	WHITE ULTRAFINE WIRE



### BATTERY HOLDERS

Plastic battery holders to fit the three most popular battery sizes used in modeling. Wire leads.

800-9611	BH-1 BATTERY HOLDER FOR 1 AA BATTERY
800-9612	BH-2 BATTERY HOLDER FOR 2 AA BATTERIES
800-9613	BH-3 BATTERY HOLDER FOR 1 AAA BATTERY
800-9614	BH-4 BATTERY HOLDER FOR 2 AAA BATTERIES
800-9615	BH-5 BATTERY HOLDER FOR 1 N BATTERY
800-9616	BH-6 BATTERY HOLDER FOR 2 N BATTERIES

**CIRCUITRON, INC.**

211 RocBaar Drive  
Romeoville, IL 60446-1163

Phone: (815) 886-9010

FAX: (815) 886-9076

E-Mail: [INFO@CIRCUITRON.COM](mailto:INFO@CIRCUITRON.COM)

WEB SITES: [WWW.CIRCUITRON.COM](http://WWW.CIRCUITRON.COM)

[WWW.PROGRESSIVEMODELDESIGN.COM](http://WWW.PROGRESSIVEMODELDESIGN.COM)